

User Manual

POS-Line Series

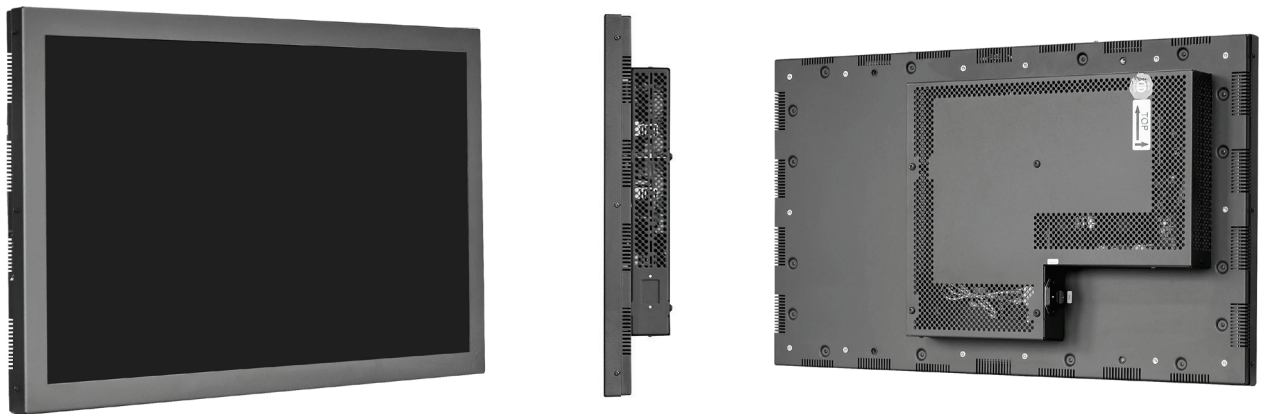

POS-Line monitors from 80 cm (32.5")
to 139 cm (54.6")



DATA DISPLAY GROUP



Copyright

The contents of this manual are subject to change without notice.

© 2016 Data Display Group. All rights reserved.

Reproduction of this manual in parts or entirely without the previous authorization of Data Display Group is prohibited.

Data Display Group is not liable for errors and collateral or subsequent damage which result from supply, deployment or any other utilisation of this document.

All product names mentioned in this document are trademarks or registered trademarks of their due owners.

Table of Contents

1. General Specifications	4
2. Chassis Versions.....	5
3. Scope of Delivery	7
4. General Safety Regulations	8
5. First Installation.....	11
6. Touch Sensors.....	14
7. POS-Line Video PME.....	15
8. POS-Line Video PIII	23
9. POS-Line IQ Ontario.....	32
10. POS-Line IQ Intel i3/i5.....	35
11. POS-Line VideoPoster.....	41
12. WebPoster	46
13. Maintenance	48
14. Guarantee / Service	48
15. Disposal.....	50
16. Declaration of Conformity	51

1. General Specifications

Scope of Document

This user manual is valid for POS-Line monitors up to 139 cm (54.6"). The POS-Line monitors are offered in different screen sizes and with various controllers and other options.

Important note: This user manual is complemented by other additional documents when indicated.

All documents are also available for download from Data Display Group web site: www.datadisplay-group.com.

POS-Line monitor versions:

POS-Line Video PME:	Monitor with integrated AD converter board, 1 x RGB, 1 x HDMI, 1 x Display Port
POS-Line Video PIII:	Monitor with integrated AD converter board, 1 x RGB, 1 x DVI, S-Video, Composite Video
POS-Line IQ Ontario:	Monitor with integrated PC board AMD Ontario, T56N CPU, 2 x 1.6 GHz
POS-Line IQ Core-i:	Monitor with integrated PC board Intel Core i5/i7
POS-Line VideoPoster:	Monitor with integrated network media player for video play lists

2. Chassis Versions

Various front bezels are available for POS-Line displays. A front bezel changes the look of the display.



Note: All photos and graphic representations in this document show open frame displays. All explanations shall also apply to displays with front bezel.

Displays with various front bezel designs:

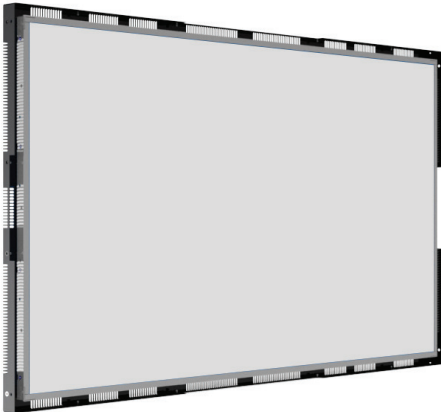
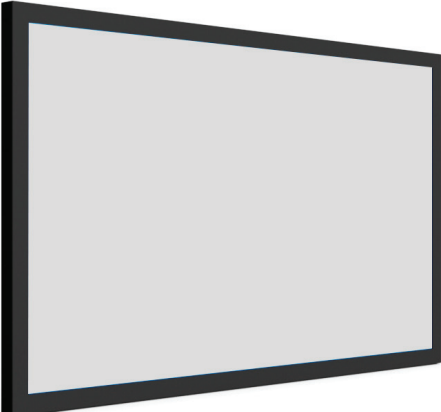
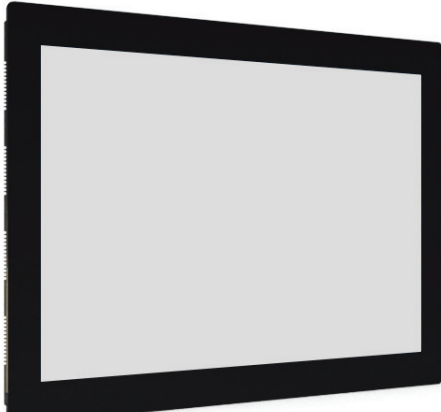
<p>Open frame display (without bezel)</p> <p>For mounting with angles or VESA mounts.</p>	 A perspective view of an open frame display without a bezel. The display panel is light gray, and the black frame is visible around the edges. The bottom edge shows the mounting brackets and connectors.
<p>Display with front bezel</p> <p>For VESA mounts.</p>	 A perspective view of a display with a front bezel. The display panel is light gray, and the black bezel is visible around the edges. The bezel has a slightly curved, ergonomic shape.
<p>Display with true-flat glass</p> <p>For VESA mounts.</p>	 A perspective view of a display with true-flat glass. The display panel is light gray, and the black bezel is visible around the edges. The bezel is flat and has a simple rectangular shape.

Display with true-flat glass and bezel

For VESA mounts.

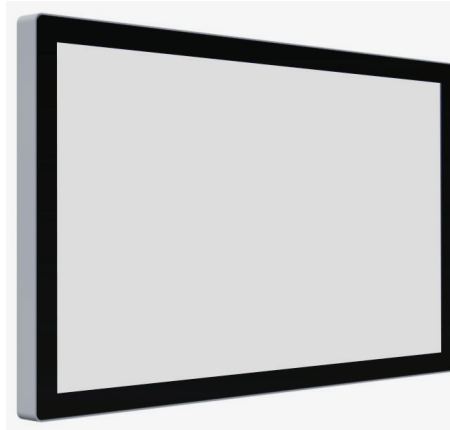

Display with aluminum bezel

For VESA mounts.

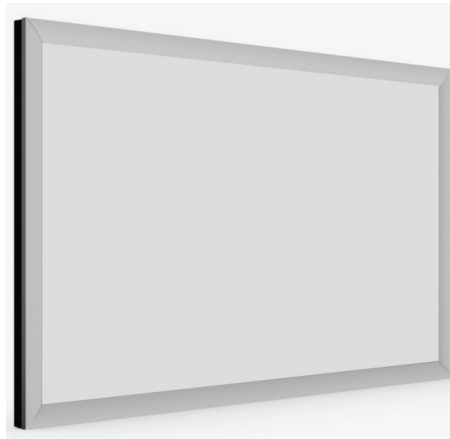

3. Scope of Delivery

When unpacking the monitor, please check if the following accessories are included in the shipment:



Note: Pictures can differ from actually supplied products.

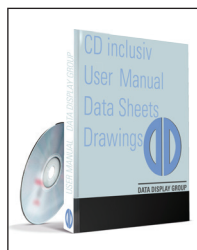

User manual



Accompanying-DVD (Manuals, Datasheets, Driver, Drawings)



RGB cable



USB cable*



Power cable**



USB stick***

* Displays with touch sensor only

** Cable may vary depending on country

*** POS-Line VideoPoster series only

4. General Safety Regulations

Safety information

Please read this safety information carefully for your personal safety and for the prevention of property damage.

In case of a malfunction, immediately disconnect the power plug and contact your dealer or the next Data Display Group service centre. A malfunction is also considered if the housing, a control element or cable is damaged or if liquids or other objects penetrate the monitor.

Please read the safety information carefully before installing the device. If you have any doubts about whether the device may be used in a particular environment, please contact our service partner.

Repairs

Repairs may only be carried out by authorized technical personnel. Unauthorized access or improper repairs might cause serious property damage or cause danger to the user. In addition to that, any legitimate warranty claim expires.

Electrical connection

Disconnect the monitor from socket before executing any work. Do not touch or connect data cables or power cables during thunderstorms.

System start-up

Before the system start-up let the monitor adjust to the room temperature. Do not expose the device to direct heat sources. In case of condensation, please wait a minimum of 12 hours before switching on the monitor. The monitor shall only be installed and used according to this documentation data sheets. Only qualified personnel may perform the initial installation and system setup.

Qualified personnel

Qualified personnel, in terms of the safety information of this documentation, are persons who are qualified to activate, ground and label devices, systems and circuits according to the safety standards.

Operation

For a proper and safe utilization of the product, adequate transportation, storage, installation, assembly, careful handling and maintenance are essential. The device is only certified for in-door operation. Extreme ambient conditions shall be avoided and the monitor shall be protected from dust, humidity and heat. Do not expose the monitor to direct sunlight.

Transport

Unpack the monitor at the place of installation. Use only original packaging for transportation. Please observe these rules for any later transport.

Condensation

Avoid condensation during transport at low temperatures or at extreme fluctuations of temperature.



Safety guidelines for the handling of LCD monitors

- If the device is not used for a long period of time, unplug the power cable.
- Do not unplug the power cable while the device is powered on, except for emergencies.
- To unplug the device without problems, sockets have to be easily accessible.
- Ensure that the power cable does not get pinched or kinked.
- Do not place heavy objects on the power cable.

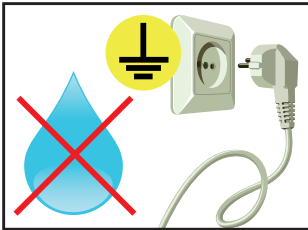

- Do not use damaged or loose sockets to plug in the device.
- Plug the device in earthed sockets only.
- Operate the device with the power cables included in the delivery packet only.
- Use undamaged power cables only.
- When plugging in and out, do not touch the power cable with wet hands.
- Ensure that the power cable is plugged in the socket safely and correctly.
- Use for devices with external power supply only the supplied original power supply, or an equivalent Low Power Source (LPS).

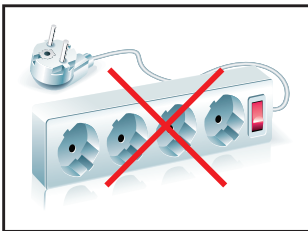

- Do not use extension block to plug several devices into a single socket.



- According to the size, devices may be difficult to handle and very heavy. Ensure that at least two people lift and carry the device.
- Put down the device slowly and carefully to avoid damaging the LCD screen. Ensure that the device stands stable.
- Keep packaging away from children. Danger of suffocation!
- Use our specified and professionally mounted wall mounting only.

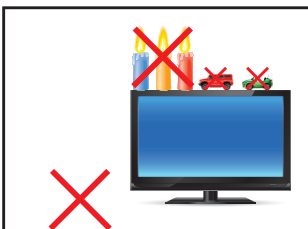

- Do not put objects onto the device.
- Do not place candles, heaters or humidifier near the device.
- Keep the device away from fireplaces and flammable materials.

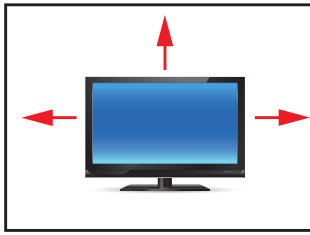

- Ensure sufficient ventilation of the device.
- Keep a minimum distance of at least 10 mm devices to the wall, for devices with integrated PC of at least 40 mm.
- Ensure compliance with the operating temperature.

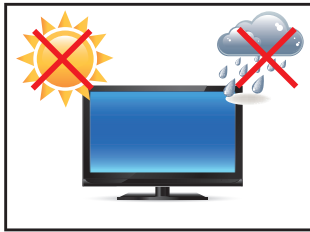

- Do not install the device in places where it is exposed to environmental impacts such as rain or direct sunlight.
- Do not install the device in places where it is exposed to high humidity, dust or smoke. In case of doubt, please contact your sales partner.



- Please use a soft, moist cloth for cleaning.
- For cleaning the screen, please use only commercially available screen cleaner. Do not spray the cleaner directly to the device but onto a cloth.
- Please clean ventilation slots regularly to ensure a good air circulation.

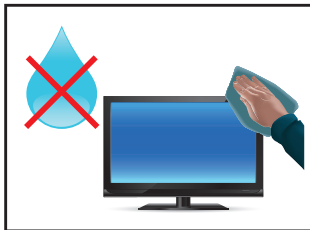

- Protect your device from water splash.
- When cleaning, please make sure that no liquids get into the device.
- Screens and surfaces can be easily scratched. Therefore, please use the prescribed cloth only.



- Attention! High voltage! Never open the device by yourself.
- In case of unusual noises, burnt smell or smoke unplug the power cable.
- Do not insert objects into the device through the ventilation slots.
- If the same picture is displayed over a longer period of time, an after-image may arise.
- When exchanging batteries, pay attention to the polarity. Keep batteries away from children and ensure an environmentally correct disposal.

5. First Installation

Position of connectors and controls

All connectors for power and cables are located at the bottom of the back side of the display.

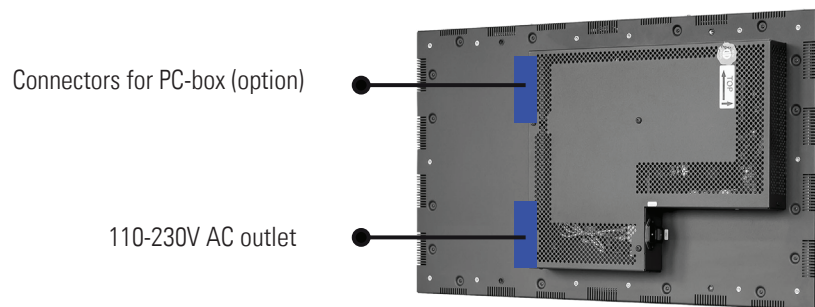
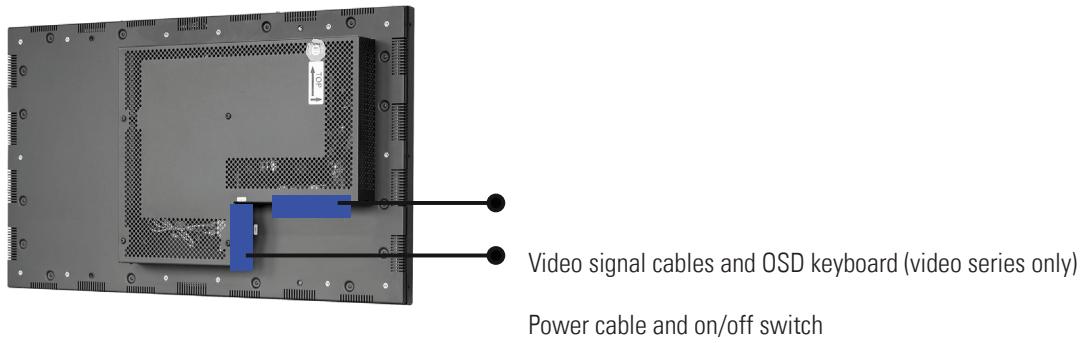

Mounting

Distance to wall:

- devices without integrated PC: min.10 mm
- devices with integrated PC: min. 40 mm

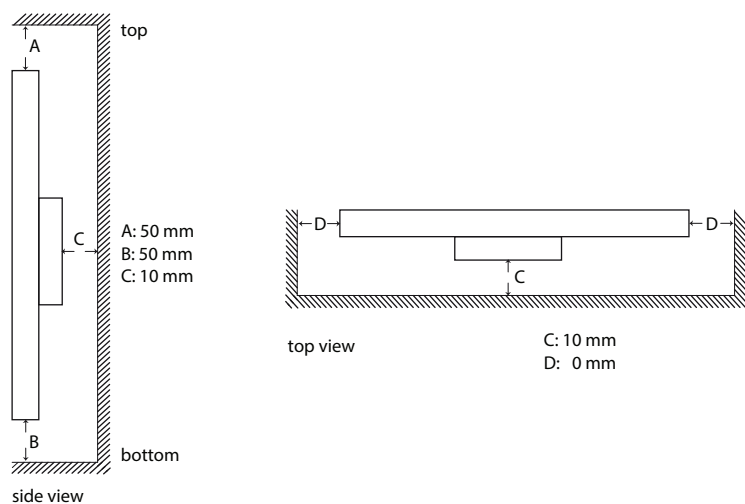

Mounting with VESA compatible brackets

POS-Line displays are shipped with factory installed mounting angles for VESA compatible brackets. The mounting angles are, without further modification suited for landscape or portrait mode and comply with the minimum required distances between the back side of the display and the wall.

The operating position of the device is perpendicular (90 degrees to the floor). Pay attention to the permissible tilt angle for wall mounting.

The device can be operated both in landscape mode and in portrait mode. The information is for positioning to note on the back of the device, always.



VESA standards:
31.5" - 54.6" displays: MIS-F 400 x 400 mm (M6)

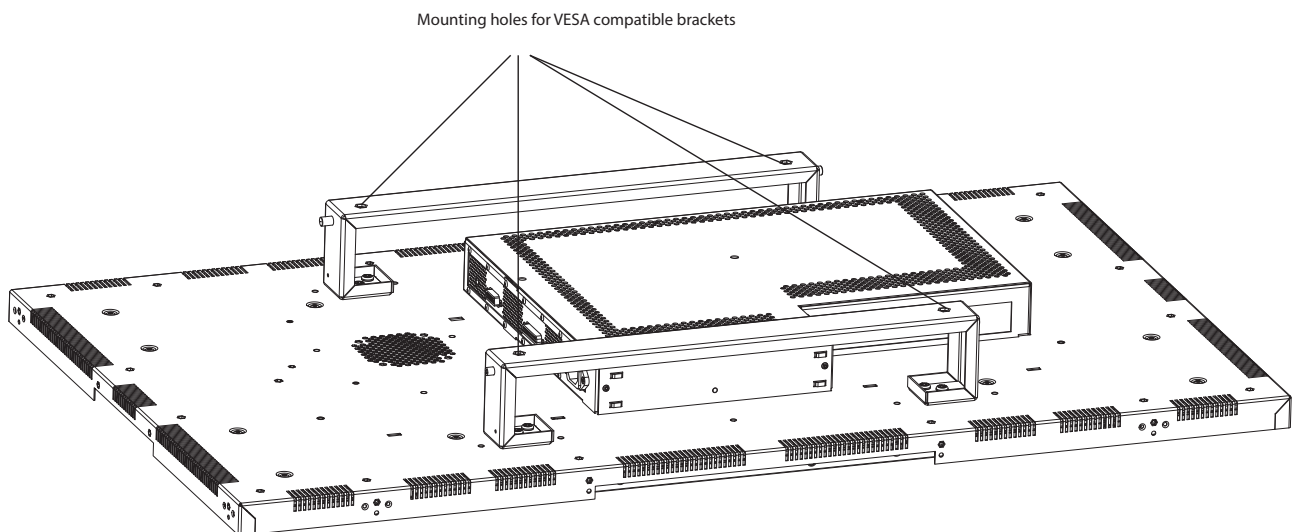

Allowed tilt angle for mounting



Attention! All monitors are not allowed to be mounted with a tilt angle of 0° - $+180^\circ$.

The following monitors may be mounted only with a tilt angle of 0° :

- All monitors with true-flat glass
- All monitors with safety glass/ touchscreen and without bezel

The following monitors may be mounted only with a tilt angle of 0° to -180° :

- All monitors without safety glass, true-flat glass or touchscreen

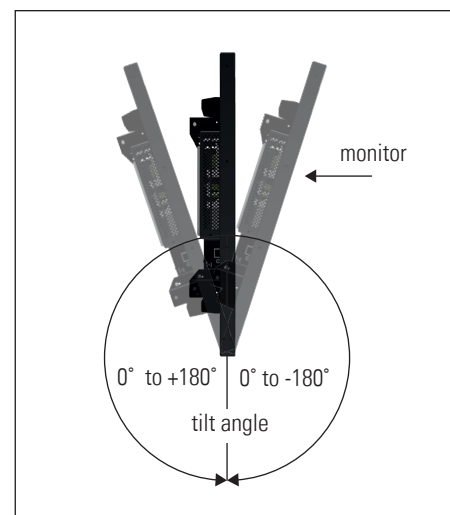

Connecting to power

POS-Line displays require a voltage of 110V - 230V AC.



Note: Install all data cables to external devices before connecting the display to power.

- Switch the on/of switch in position off.
- Connect the power cable to the display.
- Connect the power cable to a power socket.
- Switch the display on .

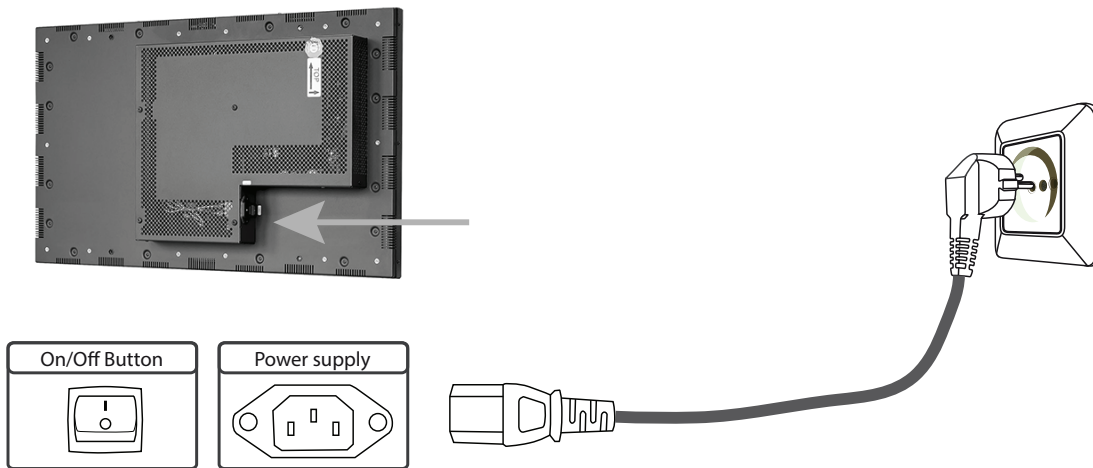

6. Touch Sensors

POS-Line monitors are available with touch option. Depending on the panel size, different touch systems and touch technologies are used. If the monitor has been ordered with touch option, the touch sensor and touch controller are installed at factory.

POS-Line IQ:

The actual touch driver is pre-installed on these systems if ordered with operating system. The touch can be put directly into operation.

POS-Line Video:

The drivers for these monitors must be installed on your PC system. HID devices do not need drivers for Windows 7 and 8. Please contact our support center if you are using LINUX based computers.

If a driver is required, the touch on this driver must be calibrated. Is it a HID Touch, Windows calibration in the control panel must be performed.

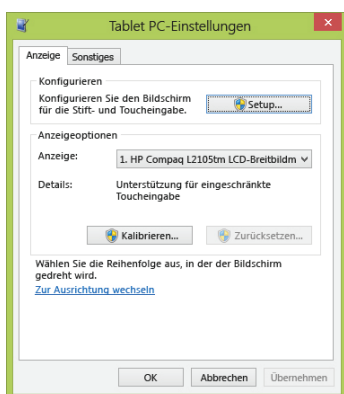

path:

Control Panel \ All Control Panel Items \ Tablet PC Settings

Note: All drivers for the touch sensors can be found on the enclosed DVD. The following table gives an overview over the touch systems including web addresses for driver downloads.

Touch system overview:

Display size	Touch technology	Touch points	Manufacturer	Type	Driver Download
31.5" - 54.6"	DST	1	3M	DST2270DX	http://solutions.3m.com/wps/portal/3M/en_US/Electronics_NA/Electronics/Tools_Support/Support/
31.5"	PCAP	10	MASTouch		HID, no driver required for Windows
31.5" - 54.6"	Infrared	4	CV Touch	F-Series	HID, no driver required for Windows

7. POS-Line Video PME

Connectors and OSD buttons of POS-Line Video PME series

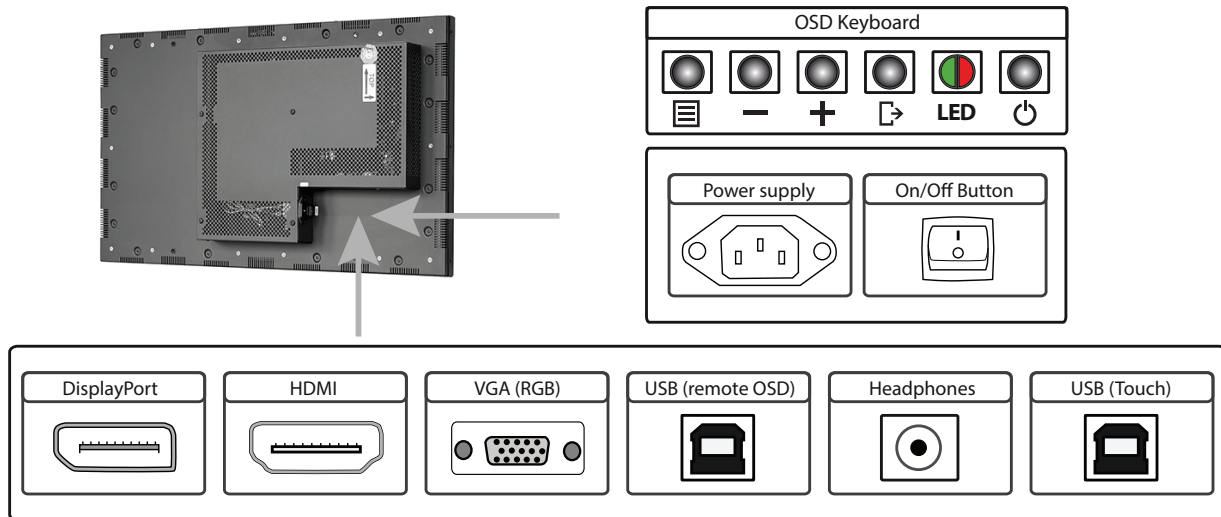

Connecting to a PC with VGA cable

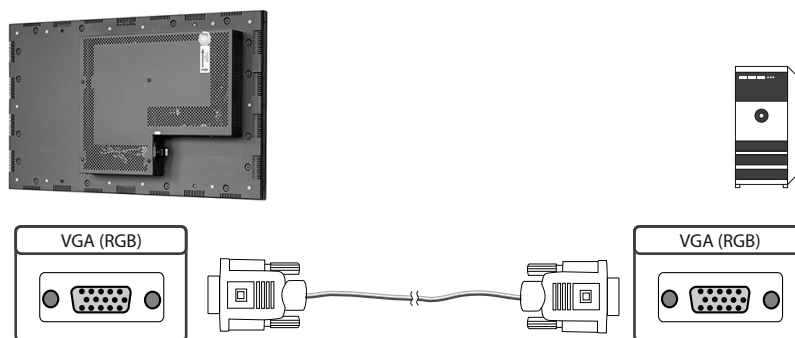

Connecting to a PC with HDMI-DVI cable

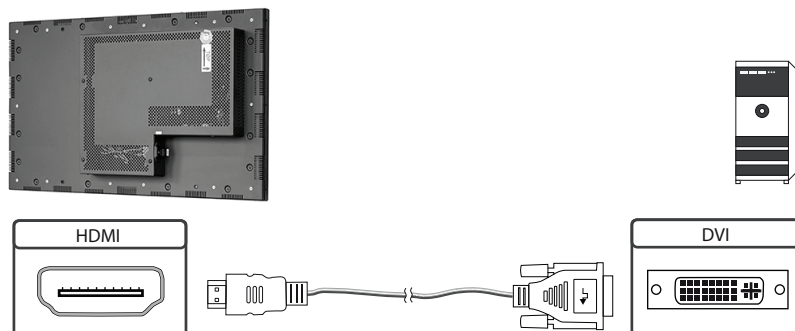

Connecting to a PC with HDMI cable

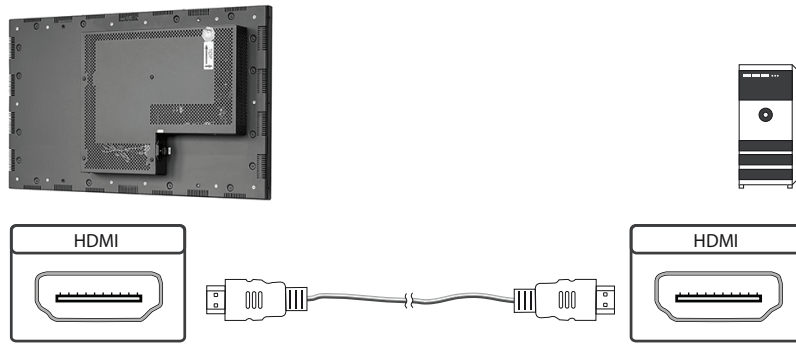

Connecting to a PC with DisplayPort cable

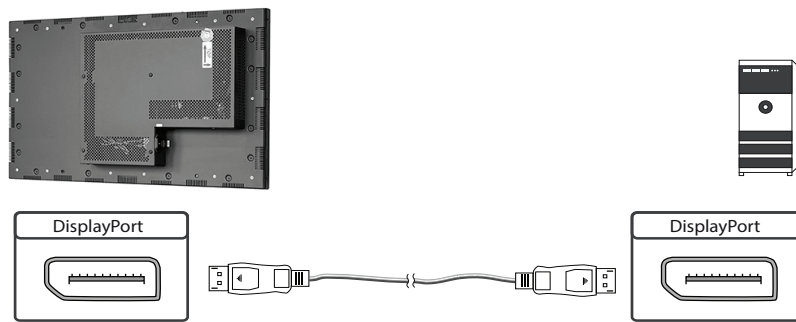

Connecting the Remote-OSD to a PC with USB cable

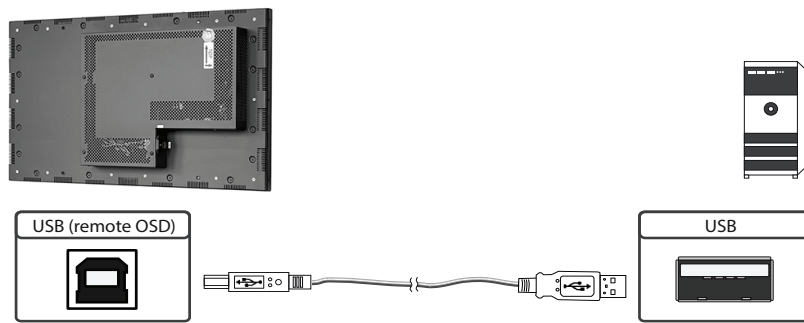

Connecting the touch to a PC with USB cable (for displays with touch sensor only)

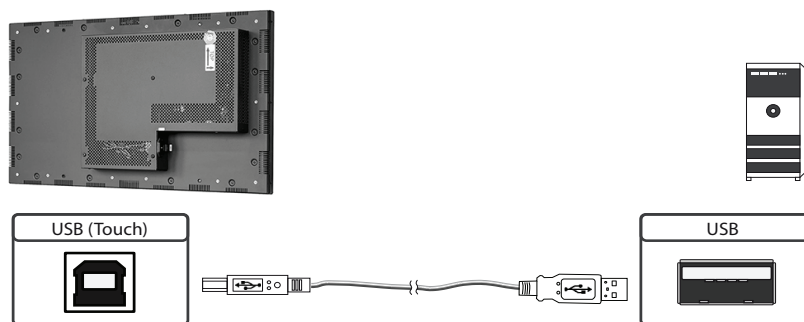

Remote OSD control

To control the OSD menu of the display remotely from a PC, use a USB cable and connect the display to your PC as described above. Please read the handbook for the remote control carefully. Please see the instructions for the remote control you find in the enclosed DVD. The document describes in detail all commands and the structure of the commands for the serial interface.

OSD keyboard

OSD functions of the monitor can be controlled via OSD key pad. The OSD allows selection of input source and fine tuning of various functional parameters like brightness, contrast etc.

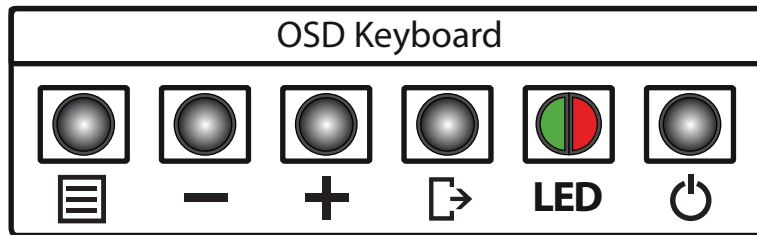

The OSD control can either be used:

- to access various functions directly
- to navigate within the OSD

The following two tables give an overview about the functions:

Direct functions:

Key	Function	Comment
Menu	Open the OSD menu	
—	Open volume control	
+	Open brightness control	
Exit	Select signal input	
Power	On/ Off	

Navigation in OSD menu:

Key	Function	Comment
Menu	Open sub menu	when in main
	Confirm entry	when in main
—	Cursor down	when in main or in sub menu
	Cursor/ slider to the left	when in main or in sub menu
+	Cursor up	when in main or in sub menu
	Cursor/ slider to the right	when in main or in sub menu
Exit	Leave OSD menu	when in main
	Leave sub menu	when in sub menu

The green/red LEDs (single package) on the external keypad show the current status of the board:

Color	Meaning	Remark
Green	Signal found	
Green blink	Search signal	
Red	Power safe mode	
LED off	Monitor off	

OSD menu

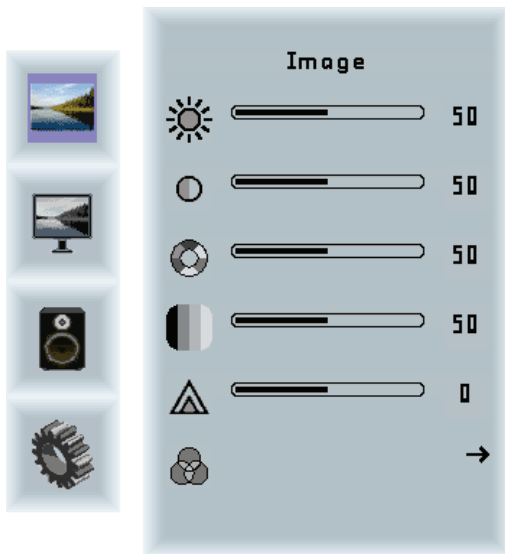

Image Menu

- Brightness: Panel brightness adjustment.
- Contrast: Panel contrast adjustment.
- Hue: Panel hue adjustment.
- Saturation: Panel saturation adjustment.
- Sharpness: Panel sharpness adjustment.
- Color: Opens the color sub menu.



Color Sub Menu

- Auto: Performs auto color adjustment.
- Color Temp: Allow selection of different color temperature schemes, predefined and custom. Available if color space of input is RGB.
- Full color: Selects full received color space.
- SRGB: Selects SRGB color space.
- XVYCC: Selects XVYCC color space.

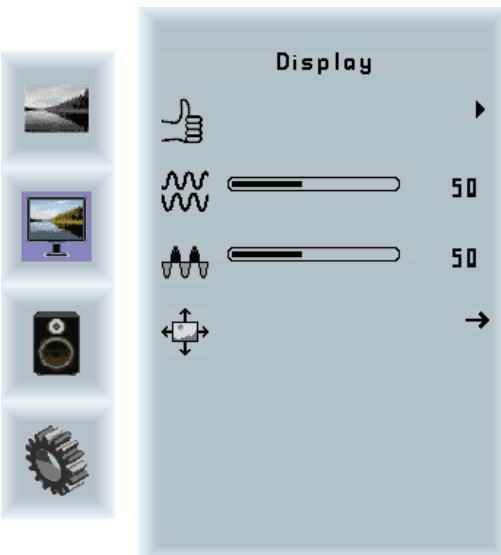
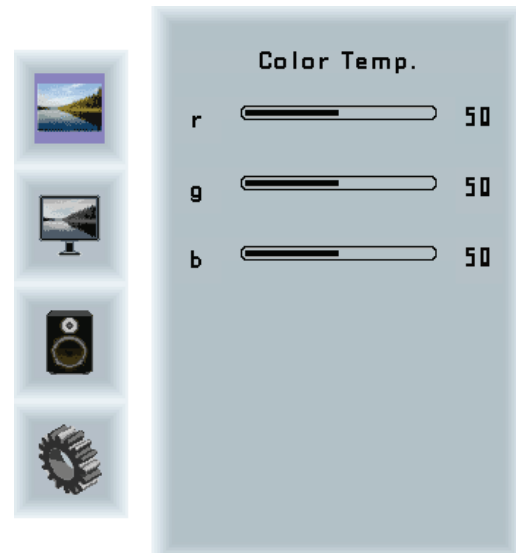

Display Menu

- Auto-adjust: Performs auto-adjustment on the VGA input image.
- Phase: This function is a slider to adjust the sampling phase of the analogue interface. For optimum image quality, input pixels should be sampled at the ideal sampling points.
- Clock: This function is a slider to adjust the sample clock of the analogue interface. This is helpful for improving the image quality for non-standard display modes.
- Position: Used to alter placement of the image.

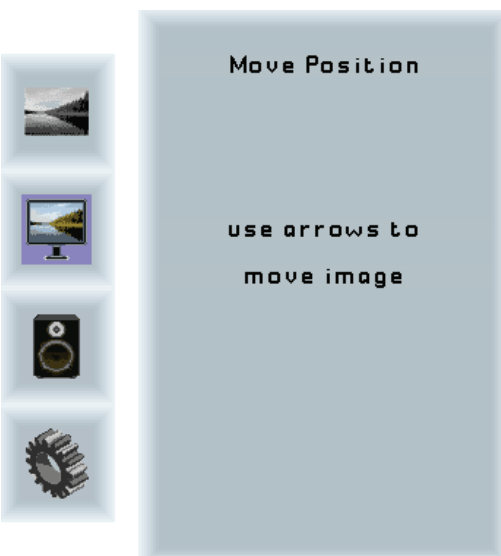

Move Position Sub Menu

- Arrows: Use arrow keys to move the position of the image on the screen.

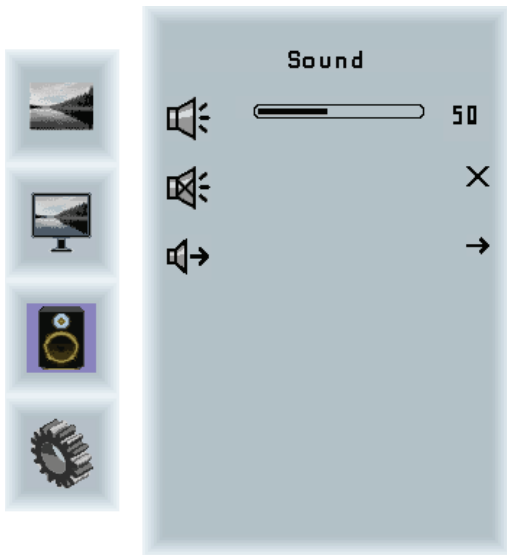

Sound Menu

- Volume: Slider bar to adjust volume.
- Mute: Mutes audio.
- Output: Chooses between speakers and headphone. Only one can be active at a time (Speakers are not available for POS-Line monitors).

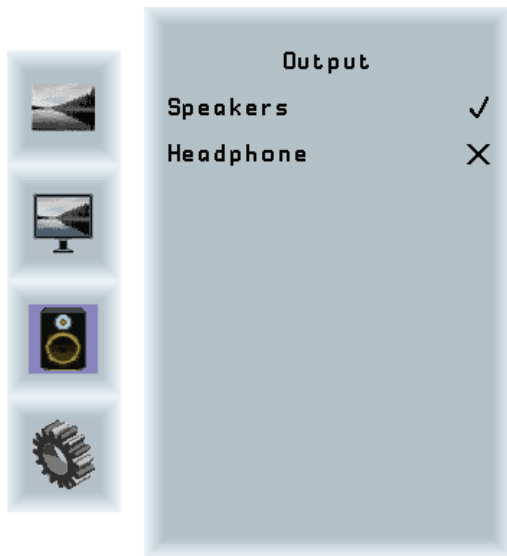

Output Sub Menu

- Speakers: Toggles speakers on/ off.
- Headphone: Toggles headphone on/ off.



System Menu

- Input source: Sub menu to select input source.
- OSD settings: Sub menu for OSD settings.
- Factory reset: Sub menu for Factory Reset.
- EDID settings: Sub menu for EDID settings.
- FW Revision: Firmware revision.
- OSD Revision: OSD revision.

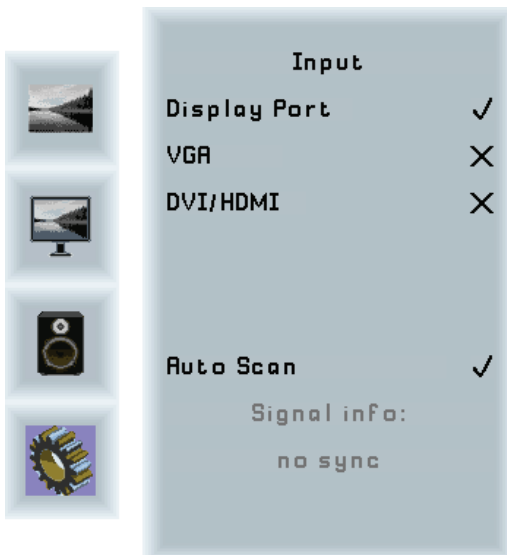

Input Sub Menu

- Display Port: Select display port as input signal.
- VGA: Select VGA as input signal.
- DVI/HDMI: Select DVI/ HDMI as input signal.
- Auto Scan: Enable/ disable input auto-scan.



OSD Settings Sub Menu

- Timer: Sub menu for timer settings.
- Rotation: Sub menu for rotation settings.
- Position: Sub menu for image position.
- Transparency: Slider to set transparency.



Timer Sub Menu

- Timer: Selects how many seconds the OSD will remain active after the last use.

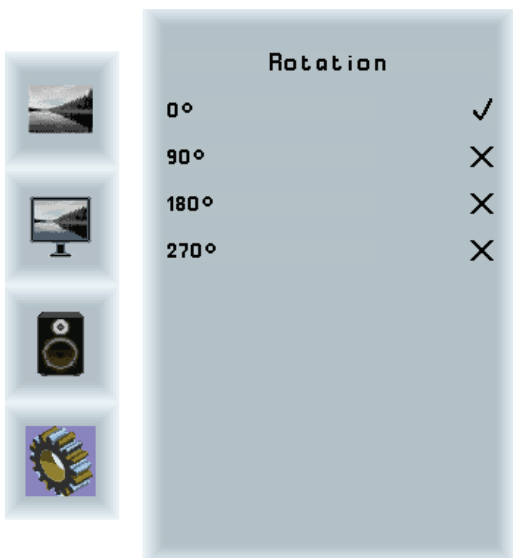

Rotation Sub Menu

Rotation: Rotates the OSD menu.



Reset Sub Menu

Reset: Performs factory reset.



EDID Write Protect Sub Menu

Write protect: EDID write protect on/ off.

8. POS-Line Video PIII

Connectors and OSD buttons of POS-Line Video PIII series

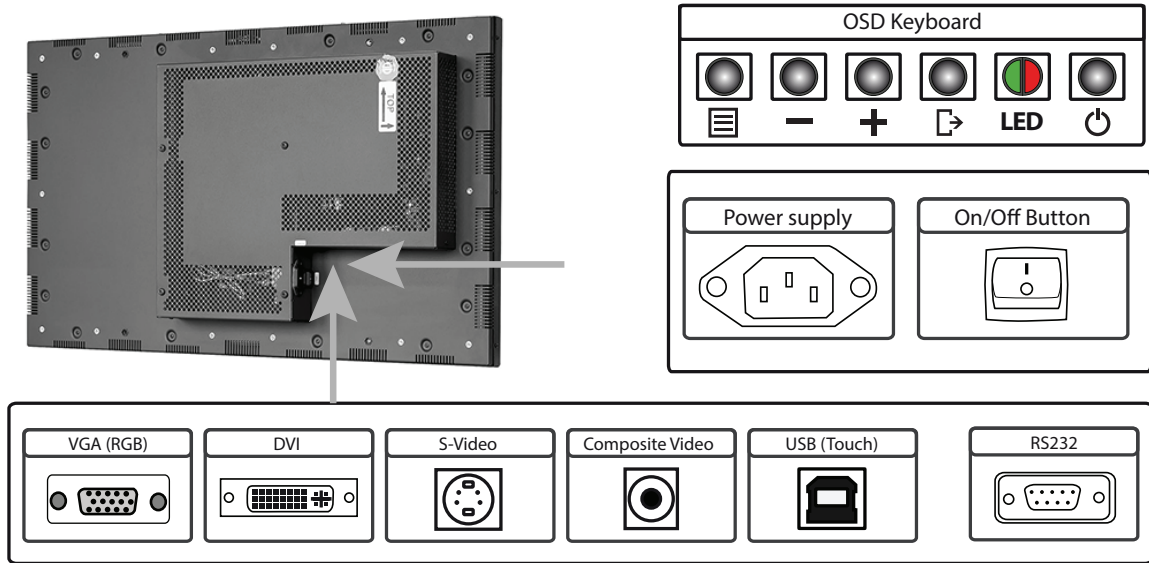

Connecting to a PC with VGA cable

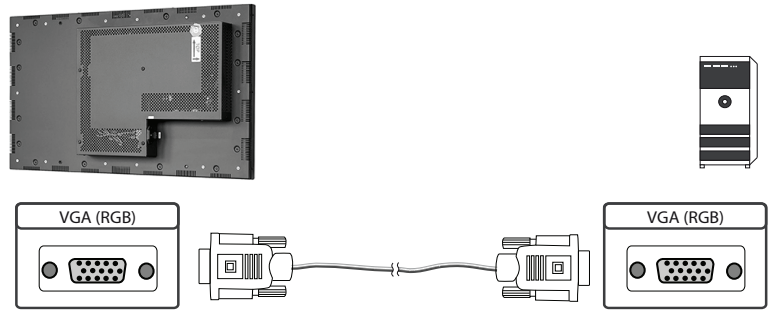

Connecting to a PC with DVI cable

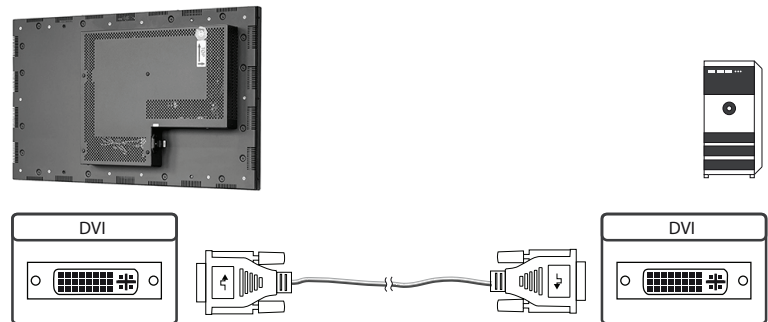

Connecting to a PC with DVI-HDMI cable

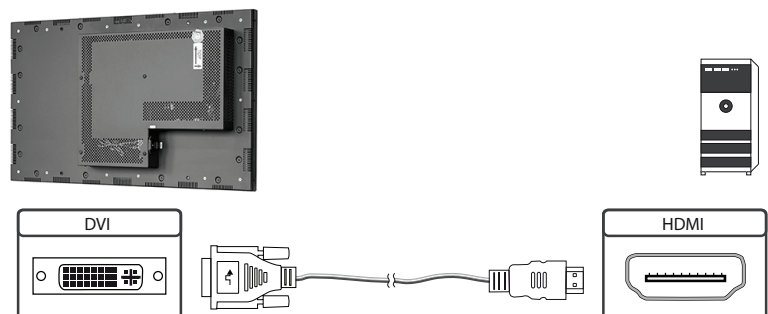

Connecting to an external device with S-Video cable

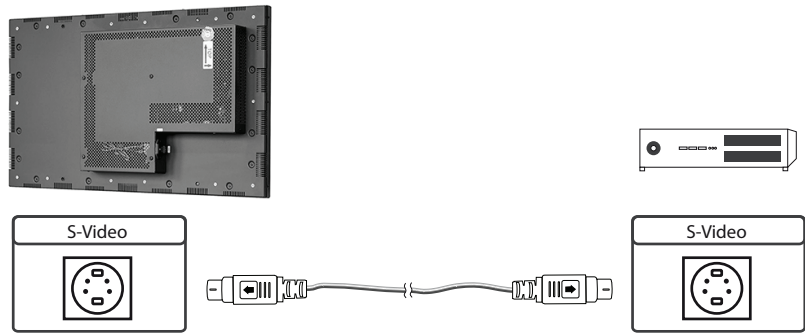

Connecting to an external device with Composite Video cable

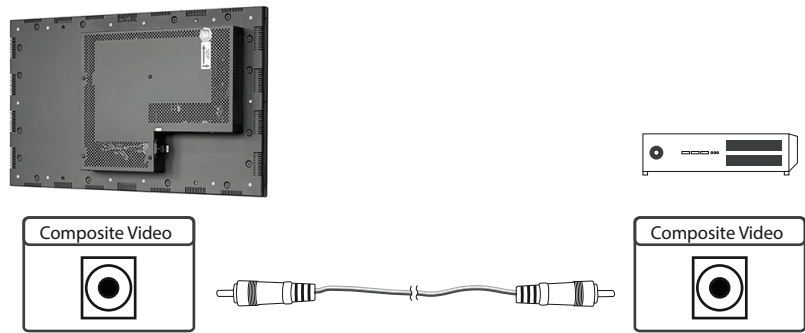

Connecting the Touch to a PC with USB cable (for displays with touch sensor only)

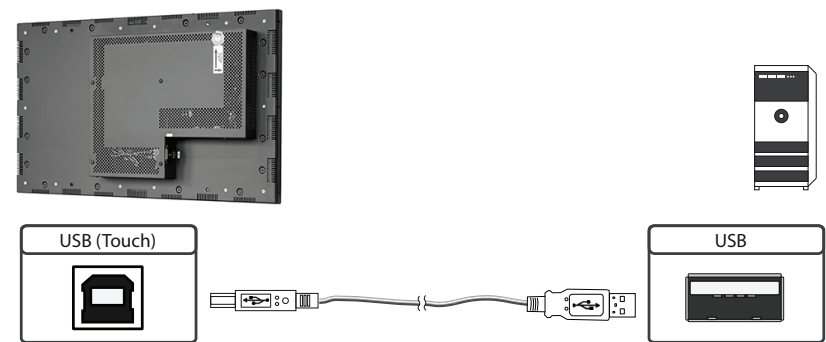

Connecting the Touch to a PC with RS232 cable (for Remote OSD only)

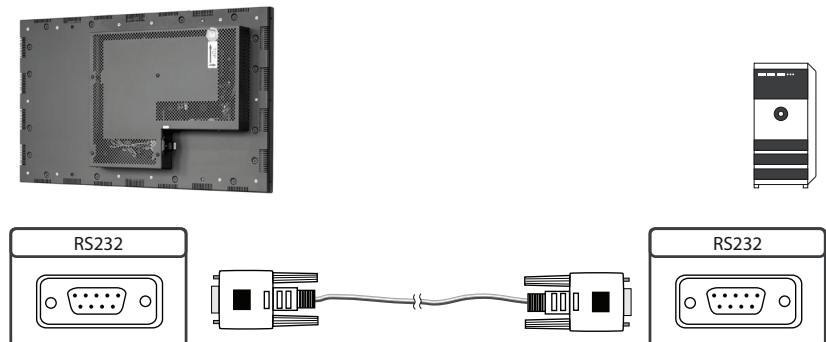

Remote OSD control

To control the OSD menu of the display remotely from a PC, use a RS 232 cable and connect the display to your PC as described above. Please read the handbook for the remote control carefully. Please see the instructions for the remote control you find in the enclosed DVD. The document describes in detail all commands and the structure of the commands for the serial interface.

OSD keyboard

OSD functions of the monitor can be controlled via OSD key pad. The OSD allows selection of input source and fine tuning of various functional parameters like brightness, contrast etc.

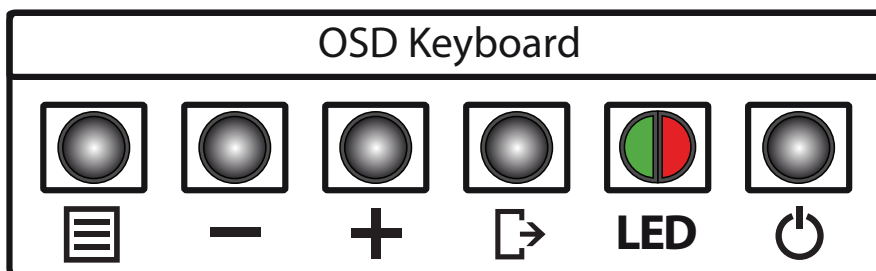

The OSD control can either be used:

- to access various functions directly
- to navigate within the OSD

The following two tables provide an overview of the functions:

Direct functions:

Key	Function	Remark
Menu	Open the OSD menu	
—	Open PIP / PAP settings	
+	Open brightness control	
Exit	Select signal input	
Power	On/ Off	

Navigation in OSD menu:

Key	Function	Remark
Menu	Open sub menu	when in main
	Confirm entry	when in main
Enter	Cursor down	when in main or sub menu
	Cursor/ slider to the left	when in main or sub menu
UP	Cursor up	when in main or sub menu
	Cursor/ slider to the right	when in main or sub menu

Exit	Leave OSD menu	when in main or sub menu
	Leave sub menu	when in sub menu

The green/red LEDs on the external keypad show the current status of the board:

Color	Meaning	Remark
Green	Signal found	
Green blink	Search signal	
Red	Power safe mode	
LED off	Monitor off	

Special functions of the controller:

- PIP (Picture in Picture): Simultaneous display of two video sources on the screen with adjustable positions.
- PAP (Picture and Picture): Side-by-side display of two video sources.
- Tiling: Display of a video source on several monitors with mutually non overlapping frames.

OSD menu

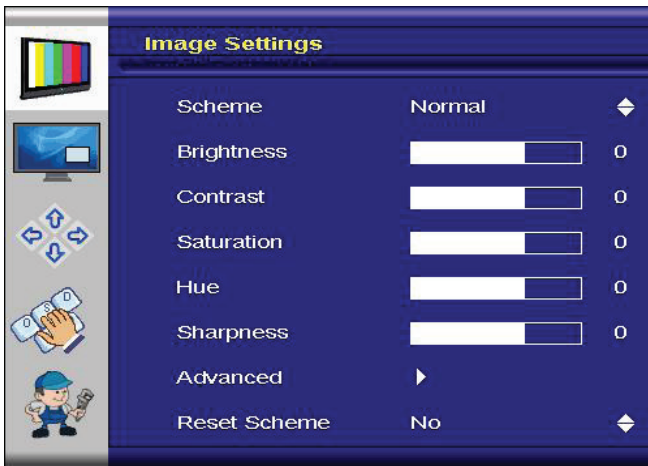

Image Settings Menu

- Scheme: Switches between normal/ sport/ game/ cinema/ vivid presetsettings.
- Brightness: Panel brightness adjustment.
- Contrast: Panel contrast adjustment.
- Hue: Panel HUE adjustment (RGB, S-Video and Composite) only.
- Saturation: Panel saturation adjustment (RGB, S-Video and Composite) only.
- Sharpness: Panel sharpness adjustment.
- Advanced: Open Advanced sub menu.



Advanced Image Settings Menu

- Note: Noise Reduction, Video Processing and Film Mode & Scaling are only available for RGB, S-Video and Composite signals.

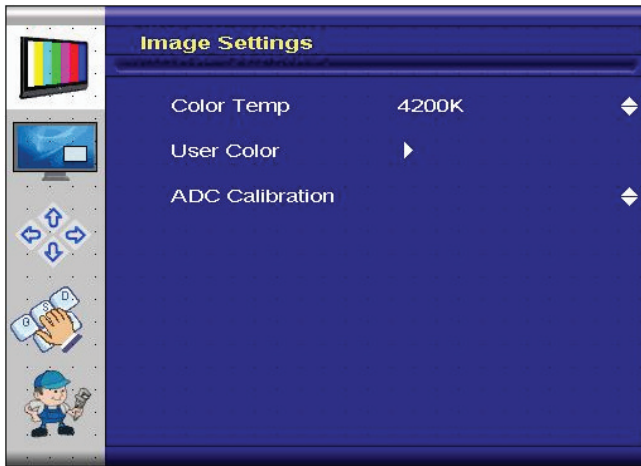

Advanced Color Sub Menu

- Color Temp:** Allow selection of different color temperature schemes. Selections are user, sRGB, 4200K, 5000K, 5400K, 6500K, 7200K, 9300K.
- User Color:** Create custom color scheme.
- ADC:** Auto Color-Adjust. Performs auto fine tuning on the ADC (RGB, S-Video and Composite only).

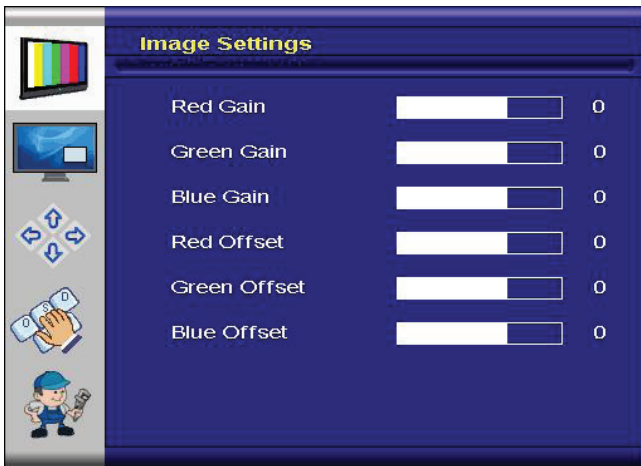

Advanced User Color Sub Menu

- Red Gain:** Boost adjustment on red.
- Green Gain:** Boost adjustment on green.
- Blue Gain:** Boost adjustment on blue.
- Red Offset:** Offset level on red.
- Green Offset:** Offset level on green.
- Blue Offset:** Offset level on blue.

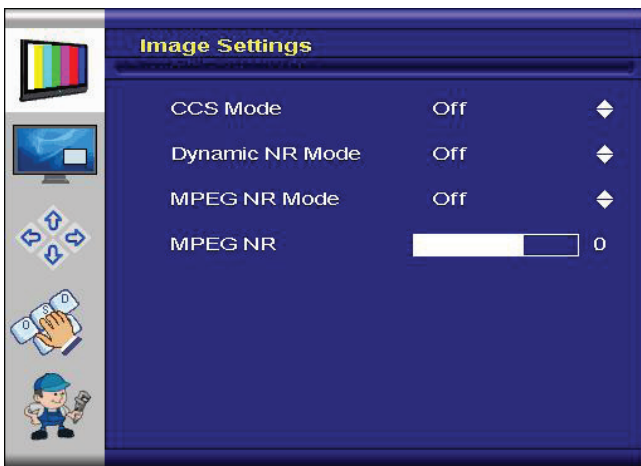

Advanced Noise Reduction Sub Menu

- CCS Mode:** Changes Cross-Color Suppression between off/ adaptive/ normal.
- Dynamic NR:** Changes Dynamic Noise Reduction between low/ medium/ high/ off/ adaptive. High setting may cause loss of detail, adjust for best image.
- MPEG NR:** Enables/ disables the MPEG NR Mode.
- MPEG NR:** Manual setting of MPEG noise reduction level.

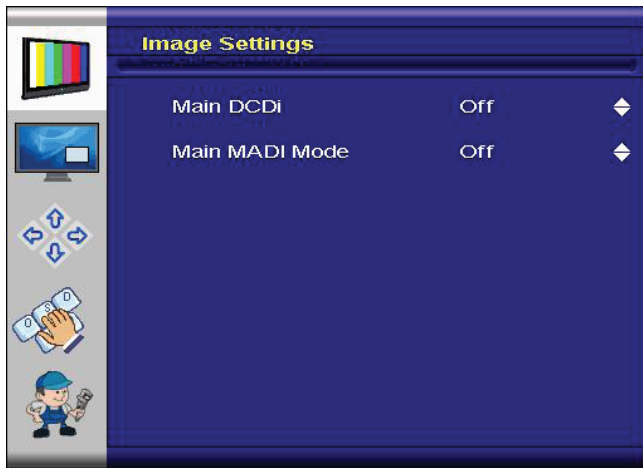

Advanced Video Processing Sub Menu

Main DCDi: Turns DCDi on/ off on main channel.
 MADi Mode: Changes Motion Adaptive De-Interlacing between normal/ off/ adaptive modes.

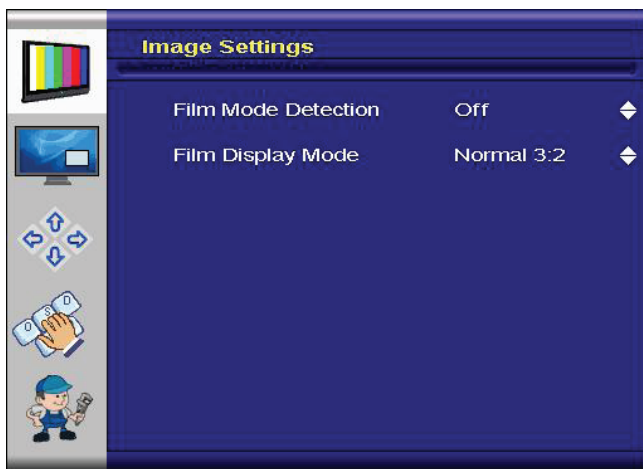

Advanced Film Mode Sub Menu

Detection: Selection of Video-3:2/ Video-2:2/ Video-3:2-2:2/ off.
 Mode: Selection of Normal 3:2 or other future modes.

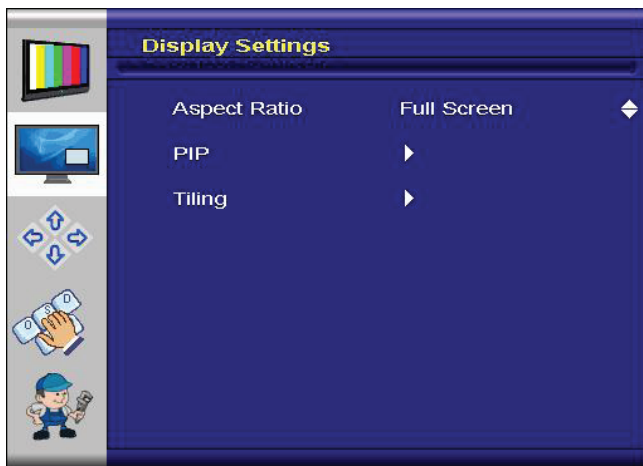

Display Settings Menü

Aspect Ratio: Used to adjust display between full screen, panoramic, Letter Box Expand, Pillar Box and 1:1.
 PIP: PIP sub menu.
 Tiling: Tiling sub menu.

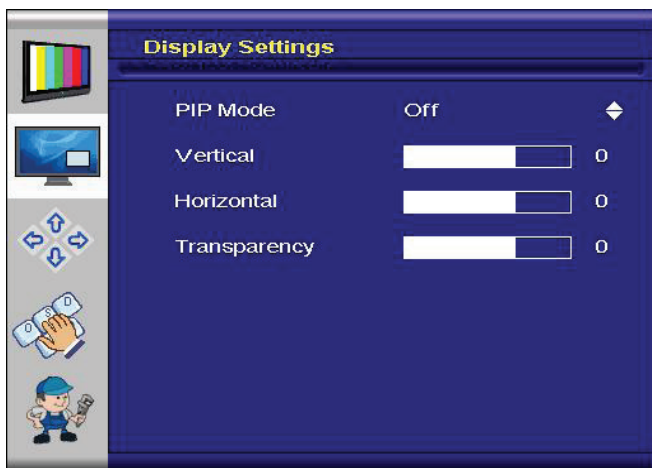

PIP (Picture in Picture) Sub Menu

- PIP mode: Toggle between Off, PAP-Tall, Side-by-Side, Small PIP and Large PIP.
- Vertical: Vertical position of PIP image.
- Horizontal: Horizontal position of PIP image.
- Transparency: Transparency of PIP image.

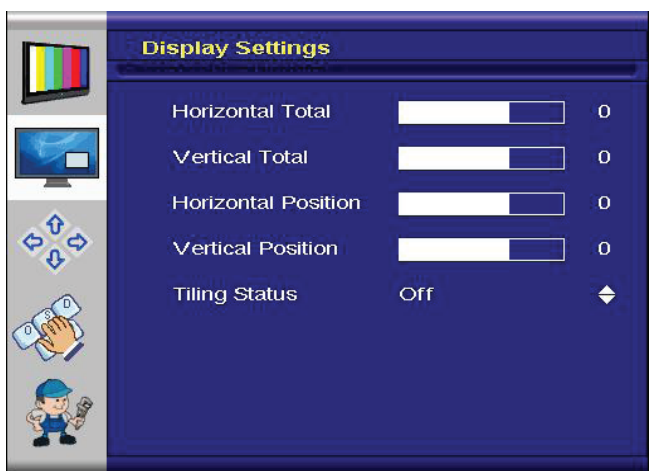

Tiling Sub Menu (for video walls)

- Horizontal Total: Defines the total horizontal number of displays.
- Vertical Total: Defines the total vertical number of displays.
- Horizontal Position: Defines the horizontal position of the actual display unit.
- Vertical Position: Defines the vertical position of the actual display unit.
- Tiling Status: Enables/ disables the tiling function. If the PIP-Mode is PAP-Tall or side-by-side, the tiling status will be off and disabled.

Example: 3 by 3 video wall: Definition of Horizontal/Vertical display position:

Position	1	2	3
1	1 / 1	2 / 1	3 / 1
2	1 / 2	2 / 2	3 / 2
3	1 / 3	2 / 3	3 / 3

Note:

- Tiling property cannot be used while PAP-Tall or Side-by-Side modes are active.
- If PIP is turned on, the PIP image would be displayed on every panel of the video wall.
- Image and position menus are disabled while tiling is on.
- For best results, the Horizontal Total and Vertical Total value should to be set to a value which is an integer divider of the input width or height, respectively. For example, if input is 1280x768, horizontal total has to be set to one of 2, 4, 5, 8 and vertical total has to be set to one of 2, 3, 4, 6, 8.

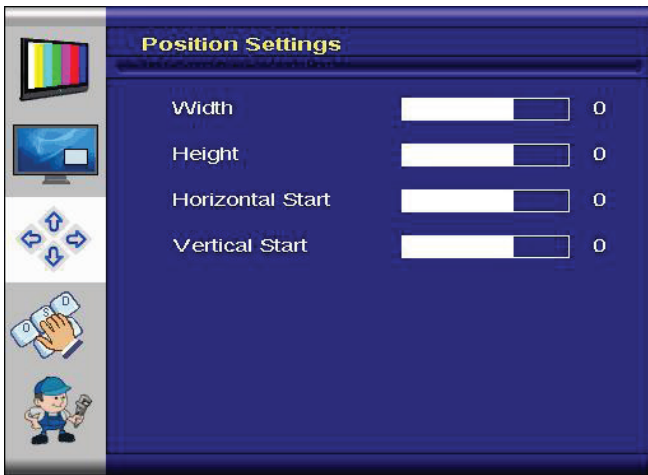

Position Settings Menu (for DVI, S-Video and Component Video Signals)

- Width: Adjusts total width of the image by stretching or shrinking.
- Height: Adjusts total height of the image by stretching or shrinking.
- Horizontal Start: Changes the starting point of the image horizontally, without altering height.
- Vertical Start: Changes the starting point of the image vertically, without altering width.

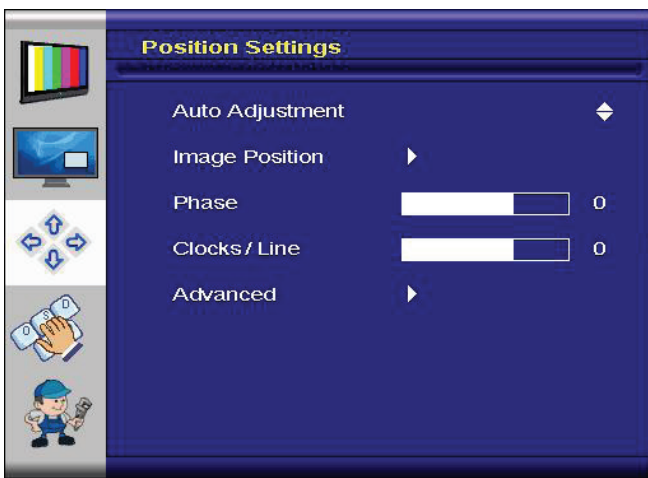

Position Settings Menu (for RGB)

- Auto Adjust: Performs auto-adjust function on the image.
- Image Position.: Image position sub menu.
- Phase: Slider to adjust the sampling phase of the analogue interface. For optimum image quality, input pixels should be sampled at the ideal sampling points.
- Clocks/Line: Slider to adjust the sample clock of the analogue interface. This is helpful for improving the image quality for non-standard display modes.
- Advanced: Advanced Settings sub menu.



Advanced Settings Sub Menu

- Note: This function can be used to manually force some of the widely used difficult-to-detect modes which can be misinterpreted by the controller.



Advanced Settings Sub Menu (DVI mode only)

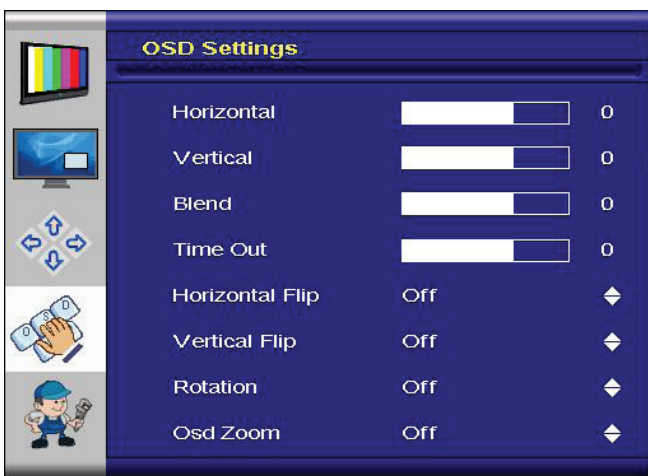

OSD Settings Menu

- Horizontal: Move the OSD in horizontal direction.
- Vertical: Move the OSD in vertical direction.
- Blend: OSD transparency adjustment.
- Time Out: This function determines after how many seconds the OSD will close itself.
- Horizontal Flip: Flips the OSD horizontally.
- Vertical Flip: Flips the OSD vertically.
- Rotation: Rotates OSD.
- OSD Zoom: Changes OSD size.



Setup Menu

- Factory Reset: Execute factory reset.
- Speed Mode: In graphics mode, fast image transfer is supported.
- Show Menu Of: Changes the menu between main image and PIP if the PIP mode is on.
- Input Search: Toggles input search on/ off.
- Auto Brightness: (Optional) Toggles automatic brightness control through external light sensor on/ off.
- Firmware Version: Installed Firmware Version.
- OSD Version: Installed OSD Version.

9. POS-Line IQ Ontario



Note: The delivery includes a driver DVD with all Ontario main board drivers!



Note: This POS-Line display is equipped with a battery. Please read the following note carefully:

- Unplug the power cable before exchanging the battery.
- There is a risk of explosion if the battery is not installed correctly.
- Replace the battery always with a battery of the same type.
- Recycle empty batteries with the free battery collection system. Please read the chapter “Disposal” in this document.

Passive cooling

POS-Line displays of the IQ series (integrated PC) are designed for passive cooling (fan-less). Passively cooled monitors have a heat pipe that routes by which the heat of the processor to a heat sink on the back of the monitor. Passively cooled devices have no moving parts.

PC specification

Please inform yourself current data sheet POS Line large about the details of the PC specification of the IQ Ontario.

Connectors of POS-Line IQ series

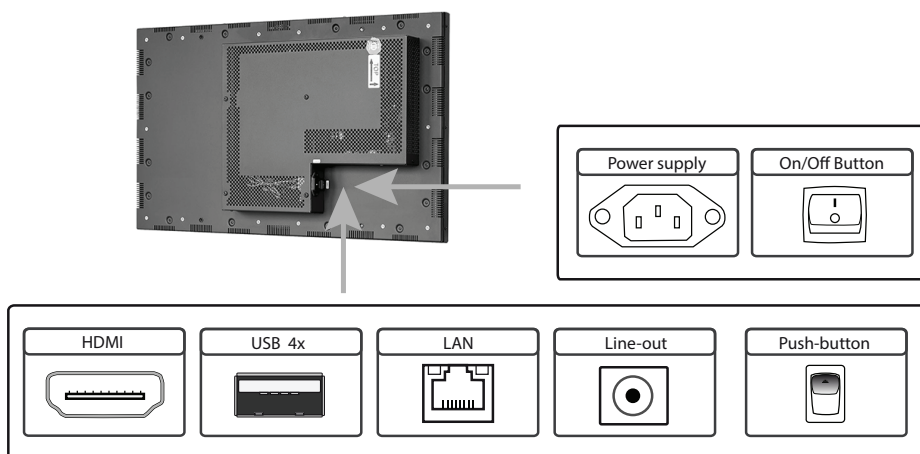

Connecting to a network using a patch cable

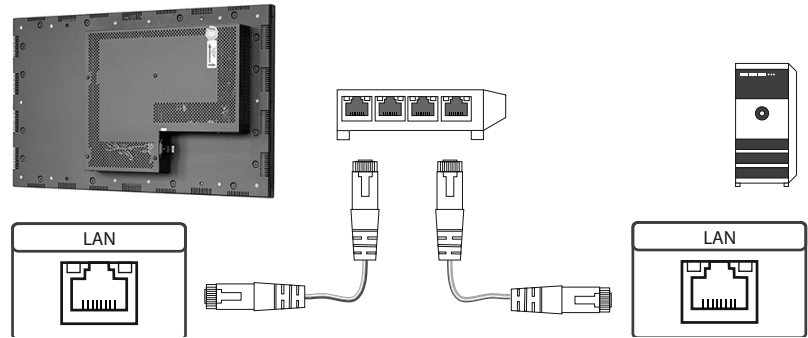

Connecting to a PC using a cross-over cable

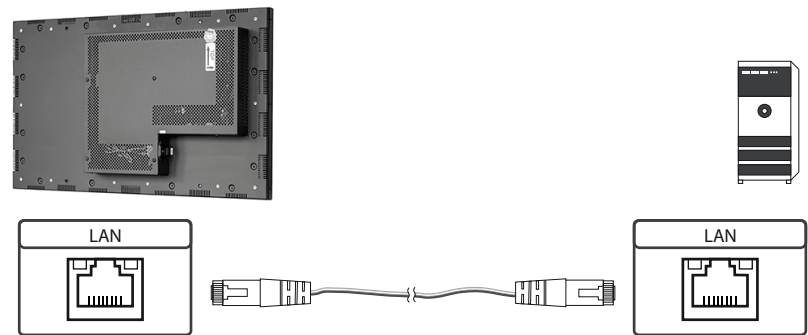

Connecting keyboard and mouse with USB cable

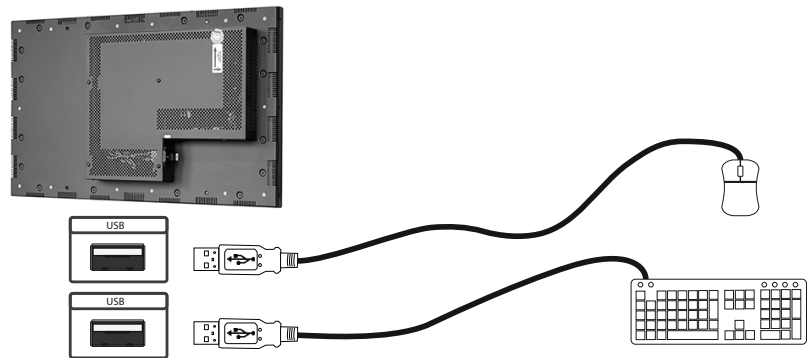

Connecting an external monitor with HDMI cable

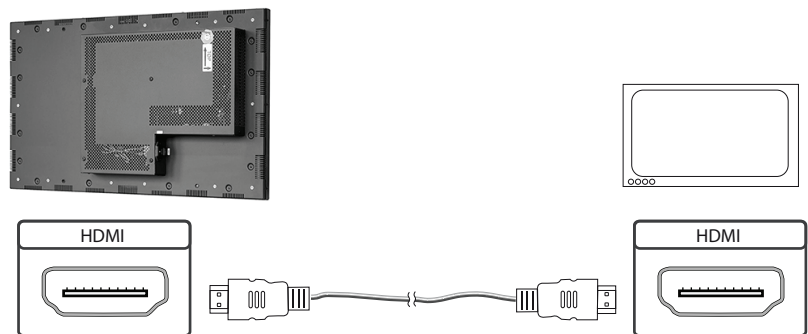

Connecting active speakers with audio cable

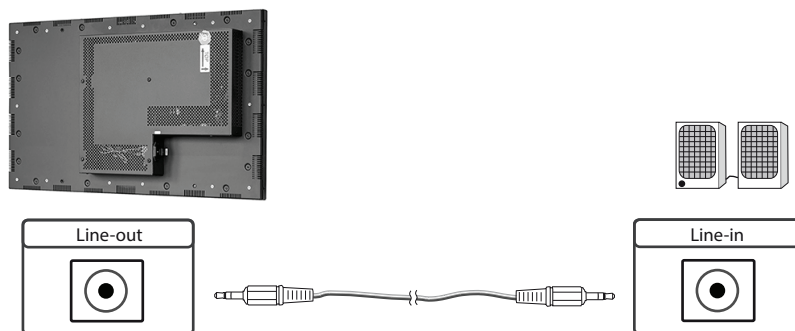

Power on/off

The display boots automatically after connecting to power. You can use the push button to switch the display on and off. In normal operation, push the push button once to shut down the system into sleep mode. The panel is switched off. If switched off, push the push button once to wake up the display.

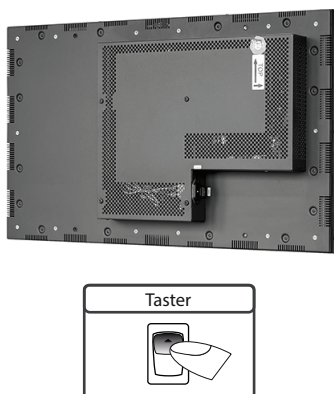

BIOS settings

A BIOS from American Megatrends Inc. (AMI BIOS) is installed on the PC main board. To change BIOS settings press the 'DAL' or 'F2' key on your keyboard during the boot process of the PC.

Operating systems

An operating system is pre-installed if your POS-Line display has been ordered with this option. In this case all main board drivers or touch drivers are installed.

Activating the operating system:

- Windows Embedded: This OS is already activated. The license key sticker is located on the back side of the display.
- Windows 7 and 8: This OS is not activated. The license key sticker is added to the product documentation. After switching on the display for the first time Windows will prompt for the key.

10. POS-Line IQ Intel i3/i5



Note: The delivery includes a driver DVD with all Ontario main board drivers!



Note: This POS-Line display is equipped with a battery. Please read the following note carefully:

- Unplug the power cable before exchanging the battery.
- There is a risk of explosion if the battery is not installed correctly.
- Replace the battery always with a battery of the same type.
- Recycle empty batteries with the free battery collection system. Please read the chapter “Disposal” in this document.

Passive cooling

POS-Line displays of the IQ Intel i3/5 series (integrated PC) are designed for passive cooling. For safety reasons, a temperature controlled fan has been integrated which is switched on if the CPU temperature exceeds a predefined temperature limit.

Passively cooled monitors have a heat pipe that routes by which the heat of the processor to a heat sink on the back of the monitor. Passively cooled devices have no moving parts.

PC specification

Please inform yourself current data sheet POS Line large about the details of the PC specification of the IQ Intel Core i3/ i5.

PC Box

The integrated PC is installed in a separate box which can be removed from the display for maintenance purposes. The PC box must be plugged into the display for operation. The display cannot be operated without PC box.

The power supply for the PC and all other data lines are integrated into the plug-and-socket connection between PC box and display. Additional cables between PC box and display are not required. A dismantled PC, box can be connected to an external power supply and operated separately from the display.



PC box

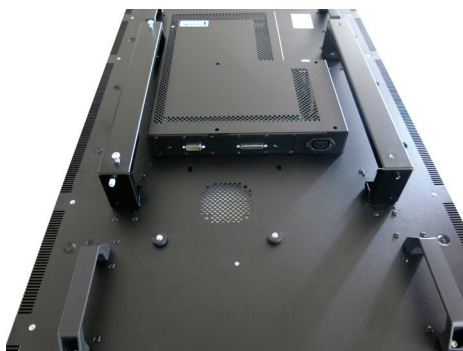

Display with dismantled PC box

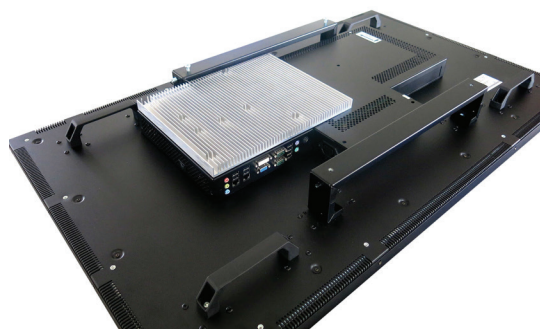

Display with PC box

Mounting and dismounting the PC box



Note: The display must be switched off before dismounting or mounting the PC box. Not conforming to the rules may electronically damage the display and the PC box.

To remove the PC box please proceed as follows:

- Make sure that the display is completely disconnected from power. Unplug the power cable or switch the monitor off with the main power on/off switch.
- Remove the safety screw (1) from the PC box .
- Pull carefully at the handle of the PC box (2) and lift the PC box from the bolts (3).

To mount the PC-box please proceed as follows:

- Make sure that the display is completely disconnected from power. Unplug the power cable or switch the monitor off with the main power on/off switch.
- Insert the PC box into the bolts (3). Make sure that the round openings at the bottom of the PC box (glide bar) are located exactly above the bolts.(4).
- Carefully plug the PC box into the connectors.
- Fasten the PC box with the safety screw.(1).

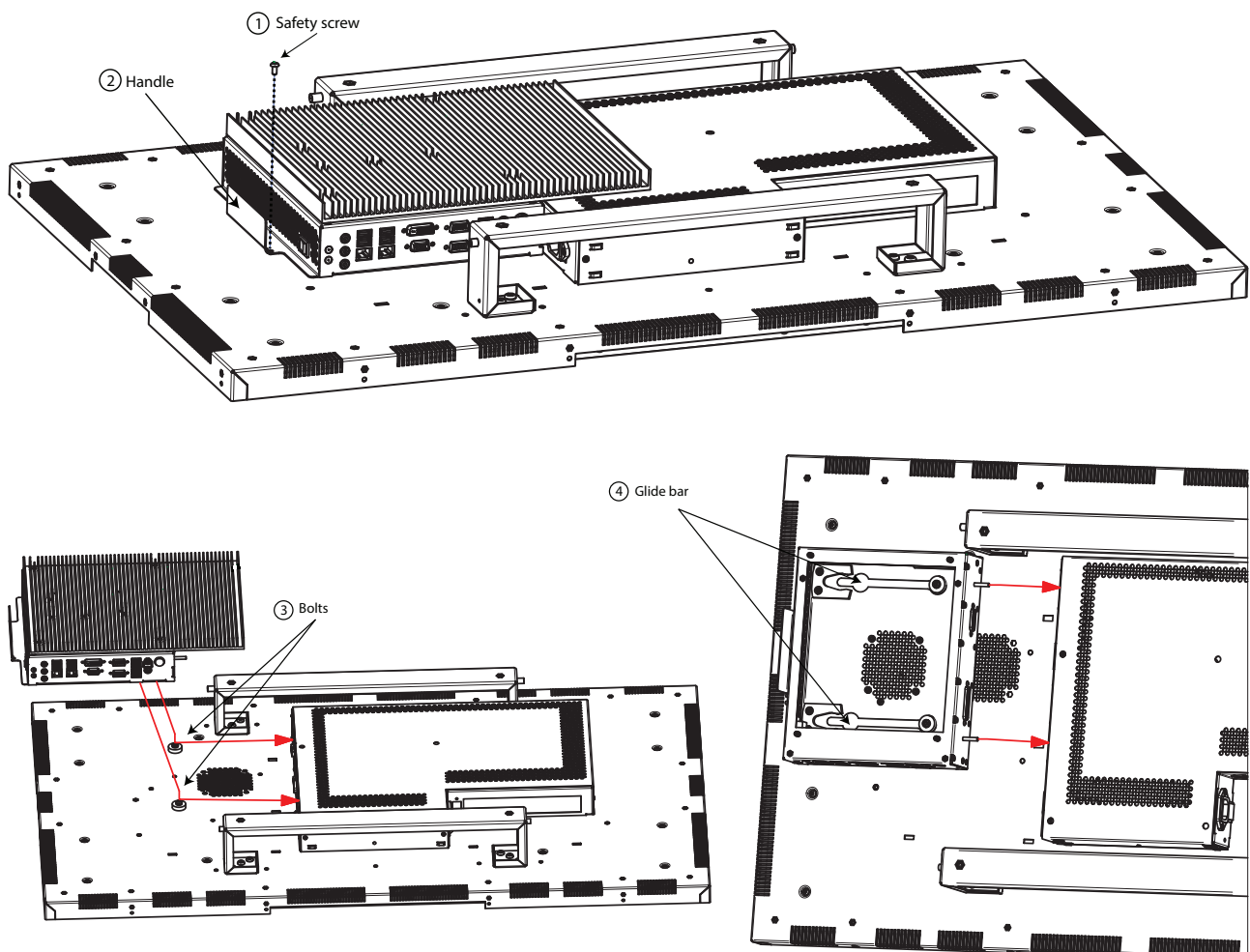

Operating the PC box without display

The PC box can be operated as stand alone device without display for maintenance purposes. This requires an external power supply (12V DC, 80 Watt) which is available as option (order number DS-30-615).

Please connect monitor, keyboard and mouse before switching on power.

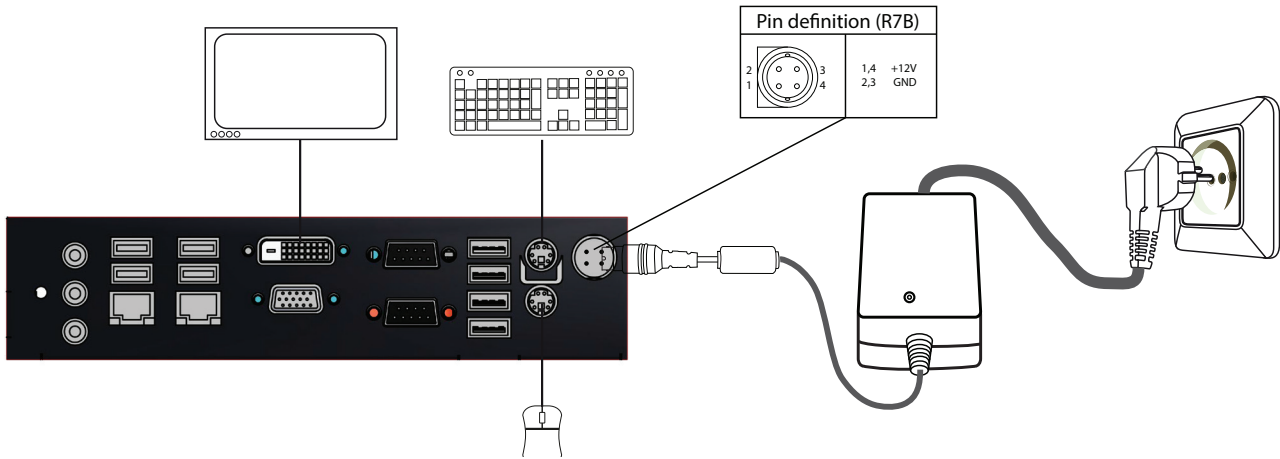

PC box connectors

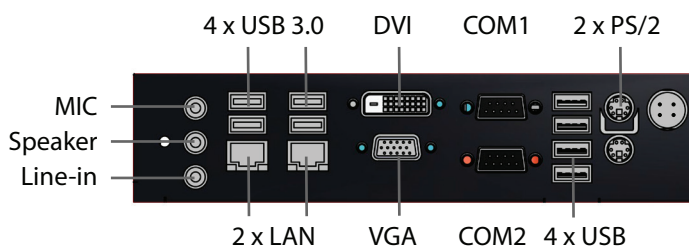

Connectors of POS-Line IQ Intel i3/i5 series

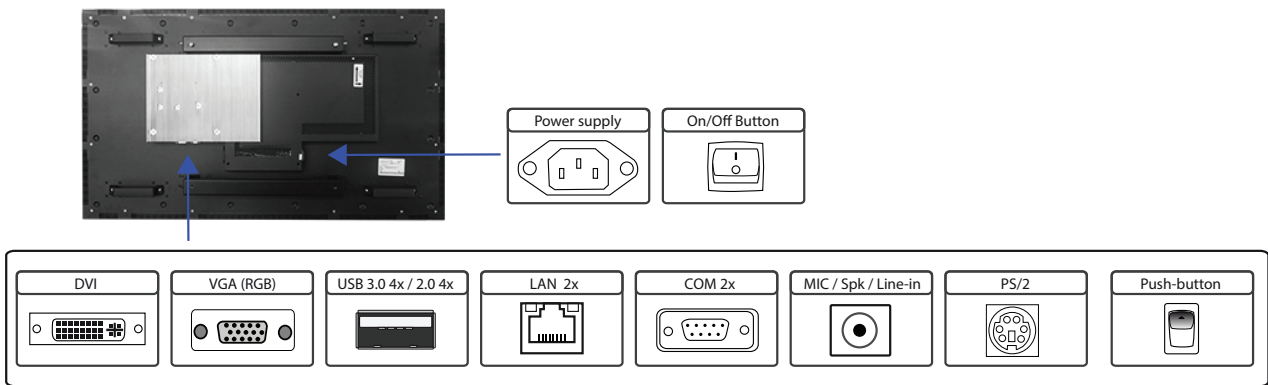

Connecting to a network using a patch cable

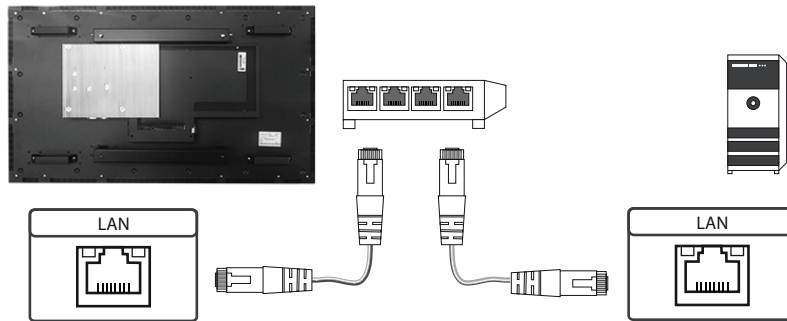

Connecting to a PC using a cross-over cable

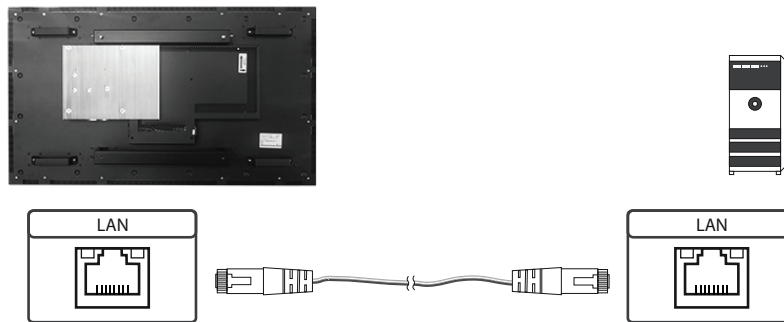

Connecting keyboard and mouse with USB cable

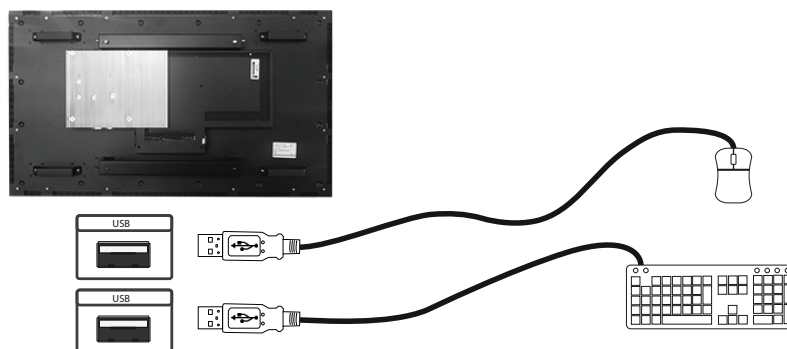

Connecting keyboard and mouse with PS/2 cable

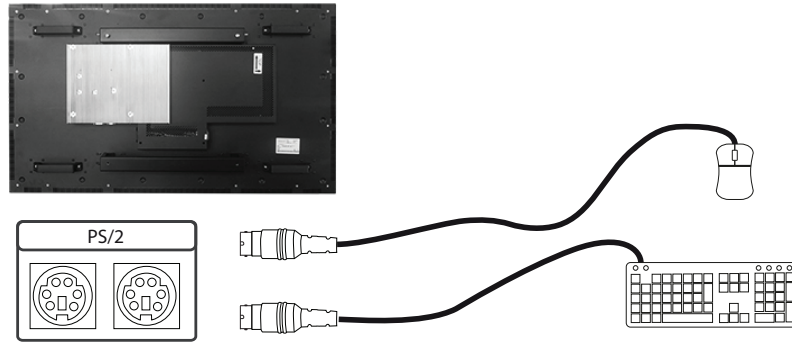

Connecting an external monitor with DVI cable

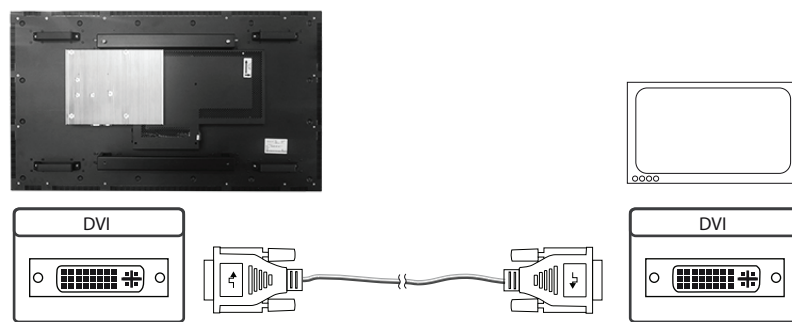

Connecting an external monitor with VGA cable

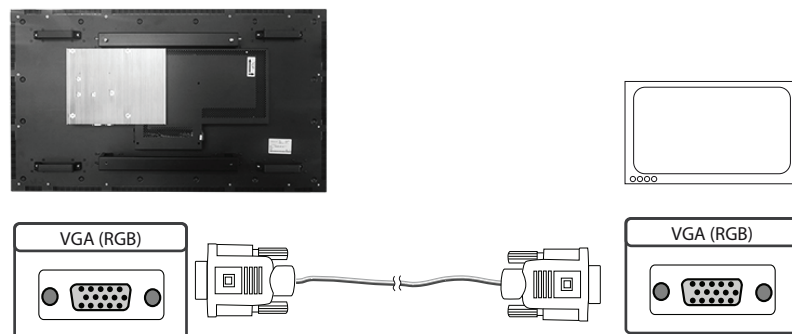

Connecting active speakers with audio cable

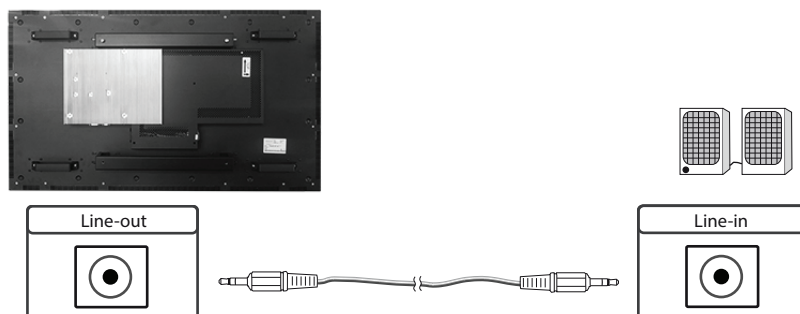

Power on/off

The display boots automatically after connecting to power. Use the push button to switch the display on and off. If in normal operation, push the push button once to shut down the system into sleep mode. The panel is switched off. If switched off, push the push button once to wake up the display.

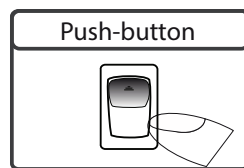
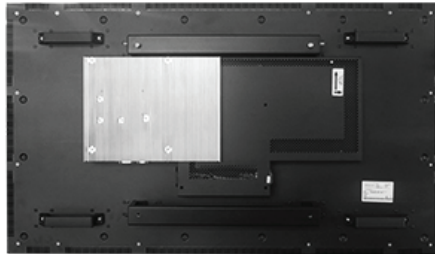

BIOS settings

A Phoenix UEFI Flash BIOS is installed on the PC main board. To change BIOS settings press the 'F2' key on your keyboard during the boot process of the PC.

Operating systems

An operating system is pre-installed if your POS-Line display has been ordered with this option. In this case all main board drivers or touch drivers are installed.

Activating the operating system:

- Windows Embedded: This OS is already activated. The license key sticker is located on the back side of the display.
- Windows 7 and 8: This OS is not activated. The license key sticker is added to the product documentation. After switching on the display for the first time Windows will prompt for the key.

11. POS-Line VideoPoster



Note: Further information on media player, play list structure, handling, utilization and supporting software modules are available at

[Http://www.datadisplay-group.com/tft-controller/industrial-mediaplayers/](http://www.datadisplay-group.com/tft-controller/industrial-mediaplayers/)



Note: This POS-Line display is equipped with a battery. Please read the following information carefully:

- Unplug the power cable before exchanging the battery.
- There is a risk of explosion if the battery is not installed correctly.
- Replace the battery always with a battery of the same type.
- Recycle empty batteries with the free battery collection system. Please read the chapter "Disposal" in this document.

Connectors of POS-Line VideoPoster series

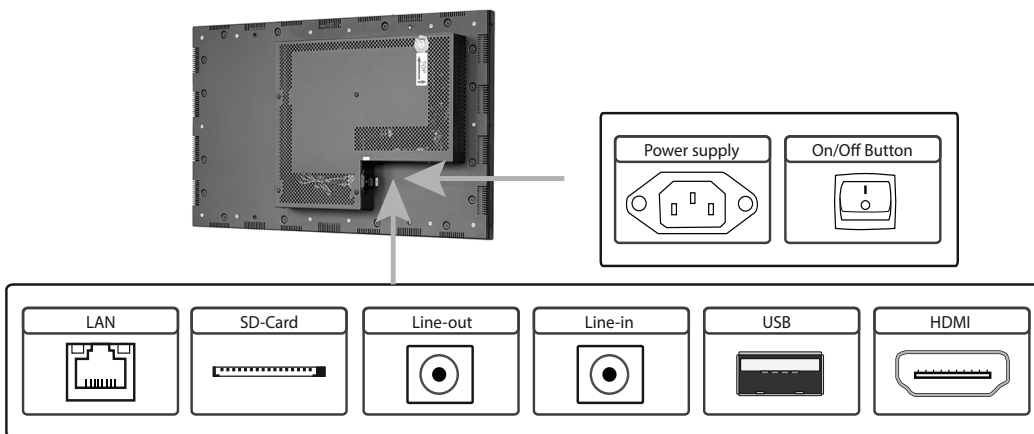

Connecting to a network using a patch cable

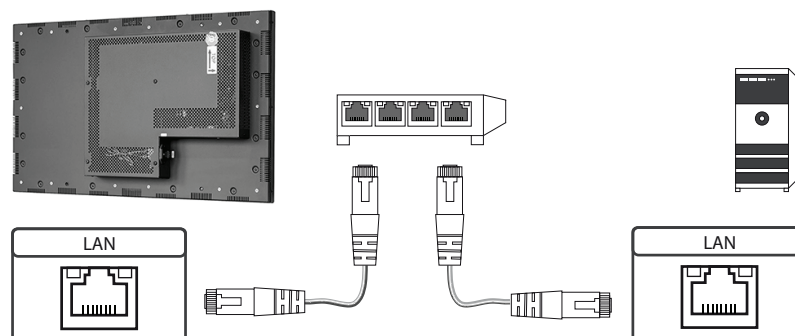

Connecting to a PC using a cross-over cable

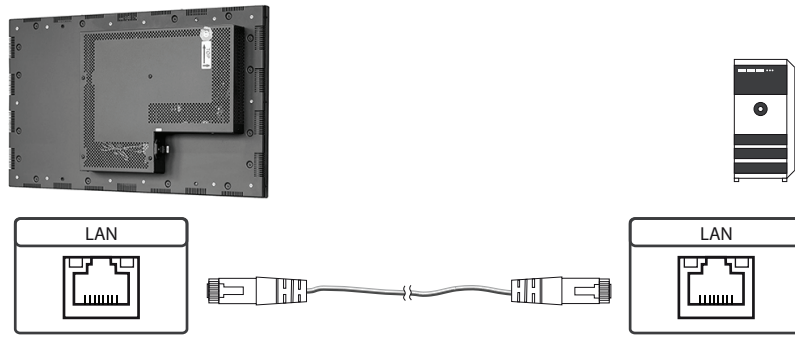

Connecting an USB stick

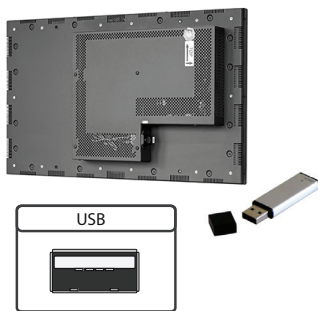

Connecting active speakers

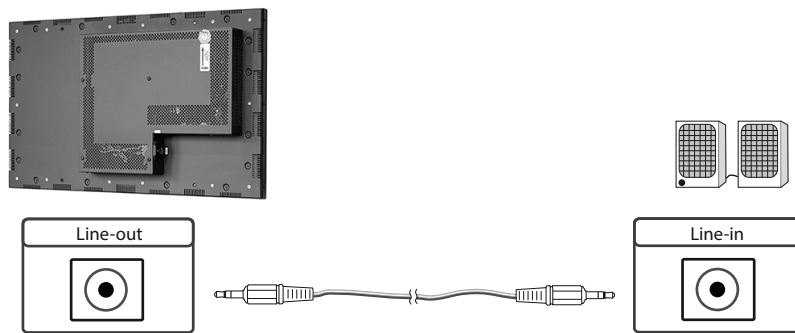

Connecting a signal source using a HDMI cable

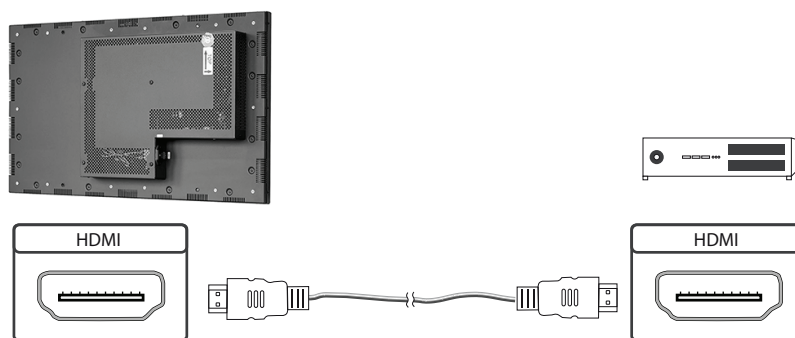

Connecting a signal source using a HDMI-DVI cable

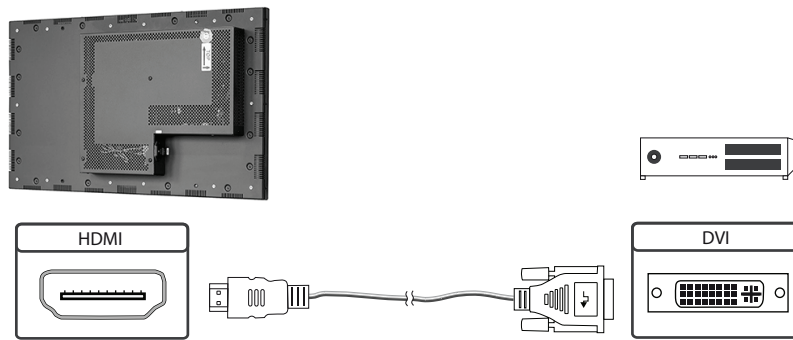

Factory configuration at the time of delivery

POS-Line VideoPoster is a network (Ethernet) device. Please note that inaccurate network configuration can have unintended influence on network operations and cause a breakdown of the entire network. To setup the device properly, you must be familiar with the basic operating parameters of your network.

Factory configuration of POS-Line VideoPoster at time of delivery:

- DHCP: off
- IP-Address: 192.168.0.1
- Netmask: 255.255.255.0
- Hostname: Videoposter-III-xx-xx-xx (last 6 bytes of the devices MAC address)
- Login Name: Artista
- Password: Artista
- FTP content update: off

SD Card

Content (play list) is stored locally on a SD card. The SD card is already installed at factory and must not be removed or plugged in during operation. POS-Line VideoPoster will not work without SD card.

Supported media formats

Video:

- MPEG-4 AVC / H.264
- Windows Media Video (WMV)
- Quicktime
- Flash Video
- MPEG Transport Stream

Still images:

- PNG
- JPG
- BMP

Functional description

POS-Line VideoPoster is a networked stand alone media player to playback play lists . Operating systems or other client-based software components are not required. Play lists are based on a XML structure and can include videos and still images. The media player is fully controlled by the play list. A play list is looped endlessly until a new play list is loaded or the player is switched off. A play list may contain several sub play lists which can be triggered by an internal timer or other external events like push buttons or proximity switches (optional external I/O board).

POS-Line VideoPoster does not need any local operation. As soon as a play list is loaded, the media player will automatically start with playback. Power can be switched off any time, a shut down procedure is not required. After power on, the media player will automatically playback the actual play list.

Connecting an external source with priority

An external source like video player or sat receiver can be connected to the POS-Line VideoPoster via HDMI. If priority of the HDMI connector has been activated, the playback of the play list will stop as soon as a HDMI signal is detected. In this case, the HDMI signal is shown on the screen. If the external player is switched off, the media player will automatically start or continuing playing back the internally stored play list.

Software

The attached CD contains the following software and documentation:

ACC: Windows software to create play lists for POS-Line VideoPoster devices. Use ACC to transfer play lists to VideoPoster, and to store play lists on USB sticks for manual transfer.

ADF: Windows software to support installation and configuration of VideoPoster devices. Connect your POS-Line VideoPoster as shipped (factory configuration) to the network. ADF will detect all VideoPosters and allow an easy configuration of the network parameters.

Downloading play lists

There are basically four methods to download play lists:

Via USB: Store the play list on a USB stick and insert the USB stick into the USB port of the display. The play list is automatically copied to the SD card and playback starts immediately.

Via ACC: This is a free software for Windows to create play lists and to upload play lists to one or more media player in the network.

Via FTP-Server: POS-Line VideoPoster will connect to the FTP server in configurable time intervals. If new content is detected, the difference to the existing play list is copied to the SD card and playback starts automatically.

Via HTTP-Protocol: Use HTTP protocol to transfer and control POS-Line VideoPoster from any existing Content Management System.

Configuration

Use any Internet browser like Firefox, Internet Explorer, Chrome, etc. for the configuration of POS-Line VideoPoster. Enter the URL (i.e. IP address or network device name) to open the device's web interface. Please enter the password if required (factory settings: Login name: Artista; Password: Artista).

Layout of the web interface:

Information

System Information:	Here you can find all information about the system like software revision. Please add a printout of this page to your mail in case of a support requests for a fast processing.
View Logs:	POS-Line VideoPoster creates log files allowing an easy monitoring of operations. Following log files are available on this page: <ul style="list-style-type: none"> Player – shows the log file of the video player and error messages. Updater – shows the log file of content updates and error messages. Setup Manager – shows the list of executed setup files. Event Manager – shows error messages of the event manager.

Configuration

Network Configuration:	This page includes all entries for the network configuration. Click on „Submit Configuration“ to store the settings and change the configuration. Clicking on „Reset Configuration“ deletes all entries in the web page but does not change the configuration.
Date and Time:	Enter date, time and time zone. Enter a network time server for automatic synchronization (NTP).
Content Auto Update:	To configure automatic content updates with FTP server, enter the FTP server access information and update time interval here.
Audio Settings:	Volume settings for speakers.
Display Settings:	Panel brightness settings.
HTTP Access:	Enter password. It is recommended to change the password after installation.
Advanced:	Firmware updates, SD card formatting, reset of hardware configuration to factory defaults and priority setting for HDMI input.

Restart

Restart:	Media player restart.
----------	-----------------------

On-screen display of IP-address and host name

IP-address and host name are shown on the screen for 5 seconds during the boot process.

12. WebPoster

Connections and controls

WebPoster are POS-Line IQ Onatrio devices with a special firmware, so the ports and operating in the „IQ Ontario“ must be observed. Connecting a mouse and keyboard is not supported with this firmware.

Functional description

The Industrial HTML Full HD Player is a complete solution for viewing Web pages. The website can be configured via a web interface. At the start of the device is automatically display.

Configuration of the media player on delivery (factory configuration)

This device is a LAN (Ethernet) enabled device. Please note that an incorrect network configuration the device may affect the safe operation of the entire network and in the worst case of a network failure leads. To set up the device for a specific network, you need the key operating parameters of the network be known. The POS Line WebPoster is shipped from the factory with the following configuration:

- DHCP: on
- IP-Address: 192.168.0.1*
- Netmask: 255.255.255.0
- Hostname: WebPoster-xx-xx-xx (the last 6 bytes of the MAC address of the device)
- Login Name: Artista
- Password: Artista

*If no DHCP server is found, this IP address is assigned automatically.

Supported site formats

- HTML5
- JavaScript

Software

On the enclosed disk contains the following software and related documentation.

ADF: A program that simplifies the installation and configuration of HTML players. Connect any HTML player in the factory configuration to the network and start ADF. It displays all the HTML players in a list. Select the devices one by one and remove the network configuration.

Configuration of the media player

The configuration of the HTML player can work with any standard web browser (Firefox, Internet Explorer, Chrome, etc.) are performed. Connect the HTML player to a network and enter to establish the connection URL (eg. as IP address or network name) in the browser. Now open the WEB interface. If you are prompted for the password, enter the password (factory setting: Login name: Artista; password: Artista).

Layout of the web interface::

Configuration

Network Configuration:	The configuration of the network is the first step in setting up.
Submit Configuration:	With Submit Configuration the entries will be accepted.
Discard Changes:	With Discard Changes be deleted entries in the fields. However, this has no influence on the current configuration.
Browser Settings:	The configuration of the Web page to display is the second step of the device. Here the web page can be entered and a „Reload Interval (seconds)“ can be defined.
Submit Configuration:	With Submit Configuration the entries will be accepted.
Discard Changes:	With Discard Changes be deleted entries in the fields.
Change Password:	Here, the default password can be changed.

Information

System Information: This page contains all details about the system, such as, for example, the software version. If you contact our Support please add this page to your E-Mail to ensure a fast response.

Restart

Restart: Restart of the media player.

Display of IP address and hostname

When booting the HTML player's current IP address and the host name of the HTML player is displayed on the screen for about 5 seconds.

13. Maintenance

Systems with active cooling require cleaning of ventilation slots every 6 months. Systems with passive cooling must be cleaned every 12 months.

14. Guarantee / Service

Guarantee

Data Display Group grants a manufacturer's guarantee of two years from the date of delivery.

The rendering of guarantee claims shall neither extend nor restart the guarantee period.

During the guarantee period, Data Display Group shall repair product faults based on material or production defects. The guarantee service is executed at Data Display Group's discretion through repair, replacement of defective parts or by exchanging a product for a product of equal quality without charging the customer for material or labor.

Guarantee claims are only accepted, if Data Display Group receives notification of a defective product within the guarantee period and the product is presented to the Data Display Group Service Centre together with all information as specified in the RMA process.

Guarantee Exclusions and Limitations

This guarantee does not apply to any defect for which Data Display group is not responsible and which includes, but is not limited to the following:

- Unauthorized opening or disassembling of the product
- Faulty maintenance by non-observation of maintenance instructions
- Inappropriate storage or cleaning of the product
- Unauthorized modification of the product
- Incorrect use or misuse
- Non-observation of operating and installation instructions
- Permanent display of fixed images (causing image retention or image sticking)
- Operating the product in conditions which exceed the limitations of the specification
- Use of inappropriate boxes, packaging or modes of shipment
- Force majeure like fire, acts of war, acts of violence, chemical or biological impacts, lightning strikes, over voltage or similar events
- Fault resulting from the use of software which was not originally supplied with the product or which is incorrectly installed
- Normal wear and tear and wearing parts (i.e. LCD panel)

Mechanical damages like scratches, pressure or break points are excluded from this guarantee.

This guarantee does not include accessory parts which are not integral part of the product (as boxes, batteries).

Pixel errors only constitute a fault under the terms of this guarantee if they deviate from the product specification (i.e. ISO 9241-307 pixel failure class II).

Display Quality - Prevention of after image burn in effects

After image burn-in means that an image or part of an image (i.e. logo) remains visible on the screen even if the image on the screen is changed. This should not occur if the LCD panel is operated in normal conditions with changing content. To prevent burn-in effects please follow the following guidelines.

- Do not display fixed patterns for an extended time period of more than 12 hours.
- Power-off the monitor for 4 hours after using it for 20 hours, and for 2 hours after using it for 12 hours.
- Use the power scheme and power management of the PC.
- Use plain-colored screen savers.
- Avoid patterns with a strong difference in brightness and contrast.
- Avoid gray colors.
- Change images and logos regularly. Show animated pictures for 60 seconds after 4 hours of operation.
- The best way to protect your display is to switch the monitor off when not in use or to use screen savers.

Non-observance of these guidelines may have effects on warranty.

Guarantee Processing

Group RMA process. In order to avoid unnecessary charges, it is important to adhere to the RMA regulations.

Products must be appropriately and professionally packed for a safe return to the Data Display Group Service Centre. Products with panel sizes equal or larger than 81 cm (32") must be shipped on pallets in upright position.

Data Display Group does not assume liability for any customer data stored on products which are returned to Data Display Group.

Limitations of Liability and Benefits

With this guarantee declaration, Data Display Group exclusively guarantees that the product is free of material and manufacturing faults.

Data Display Group does not issue any other guarantee or similar statements other than this declaration.

This guarantee does not impair or affect a buyer's statutory claim against the seller due to material damage. Such claims can be asserted instead of the guarantee agreed to here at the buyer's discretion.

Mandatory legal rights and mandatory claims under the German Product liability remain unaffected.

Applicable Law and Place of Jurisdiction

The laws of the Federal Republic of Germany apply.

Place of jurisdiction is Munich.

Service addresses

Germany

Distec GmbH
 Augsburg Str. 2b
 D-82110 Germering
 ☎ +49 (0)89 / 89 43 63 0
 ✉ support@distec.de

Great Britain

Display Technology Ltd.
 5 The Oaks Business Village
 Revenge Road, Lordswood
 Chatham, Kent, ME5 8LF
 ☎ +44 (0)16 34 / 67 27 55
 ✉ info@displaytechnology.co.uk

USA

Apollo Corp.
 87 Raynor Avenue, Unit 1
 Ronkonkoma NY 11779
 ☎ +1 (1)631 / 580-4360
 ✉ info@apollodisplays.com

Please go to the following web address for further information about our RMA regulations and RMA forms:

[Http://www.datadisplay-group.com/service](http://www.datadisplay-group.com/service)

15. Disposal

Disposal of old devices

If the acquired Distec product is to be disposed of, must be implemented into national law the Directive "2012/19 / EU".

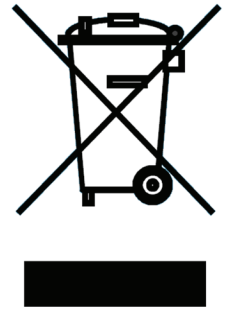

Disposal of batteries

Applicable in all countries of the EU and in countries with separate battery collection systems.

The Batteries in this product should not be disposed with other household waste. The chemical symbol Pb, CD or Hg indicate that the battery contains lead, cadmium or mercury above the reference level in EC directive 2006/66.

Batteries which are not disposed correctly can cause harm environment and health.

Our environment is close to our hearts. Please help us to protect our environment and recycle empty batteries with the free battery collection system.

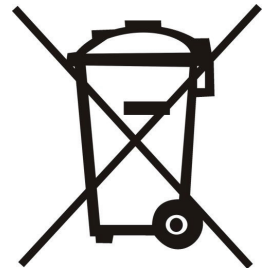

16. Declaration of Conformity

Declaration

Hereby the Distec GmbH declared that the unit EU is in compliance with the essential requirements and other relevant provisions of Directives 2014/30 / EU and 1999/5 / EC and 2014/35 / EU and 2011/65 /.

The CE declaration of conformity can be found in English on the enclosed companion DVD.

FCC-Declaration of conformity

This equipment has been tested and found to comply with the limits for a Class A digital device, pursuant to Part 15 of the FCC Rules. These limits are designed to provide reasonable protection against harmful interference when the equipment is operated in a commercial environment. This equipment generates, uses and can radiate radio frequency energy and, if not installed and used in accordance with the instruction manual, may cause harmful interference to radio communications. Operation of this equipment in a residential area is likely to cause harmful interference in which case the user will be required to correct the interference at his own expense.

Canadian Department of Communications Compliance Statement

This Class A digital apparatus meets all requirements of the Canadian Interference-Causing Equipment Regulations.

Observation des normes-Class A - Cet appareil numérique de la classe B est conforme à la norme NMB-003 du Canada.

FCC Information:

- Changes or modifications not expressly approved by Distec GmbH could void the user's authority to operate the equipment.
- Use the attached specified cables with the POS-Line monitor so as not to interfere with radio and television reception.
- Please use the supplied power cord or equivalent to ensure FCC compliance.
- Please use the supplied shielded video signal cable, Mini D-SUB 15 pin to Mini D-SUB.