



OUR GLOBAL
COMPETENCE
CENTRES

 APOLLO DISPLAY
TECHNOLOGIES



 DISTEC



 DISPLAY
TECHNOLOGY



Datasheet

InnoLux

S850DJJ-T05

CH-01-081

- Tentative Specification
- Preliminary Specification
- Approval Specification

MODEL NO.: S850DJJ

SUFFIX: T05

Revision:	
Customer:	
APPROVED BY	SIGNATURE
Name / Title _____	
Note _____	

Please return 1 copy for your confirmation with your signature and comments.	

Approved By	Checked By	Prepared By
Chihfan Ting	SJ Chien	Sharifa Chung

CONTENTS

CONTENTS.....	2
REVISION HISTORY	4
1. GENERAL DESCRIPTION	5
1.1 OVERVIEW	5
1.2 FEATURES	5
1.3 GENERAL SPECIFICATIONS.....	5
1.4 MECHANICAL SPECIFICATIONS.....	6
2. ABSOLUTE MAXIMUM RATINGS	7
2.1 ABSOLUTE RATINGS OF ENVIRONMENT	7
2.2 PACKAGE STORAGE	8
2.3 ELECTRICAL ABSOLUTE RATINGS.....	8
2.3.1 TFT LCD MODULE	8
2.3.2 BACKLIGHT CONVERTER UNIT	8
3. ELECTRICAL CHARACTERISTICS.....	9
3.1 TFT LCD MODULE	9
3.2 BACKLIGHT CONVERTER UNIT	11
3.2.1 CONVERTER CHARACTERISTICS.....	11
3.2.2 CONVERTER INTERFACE CHARACTERISTICS	13
4. INPUT TERMINAL PIN ASSIGNMENT.....	15
4.1 TFT LCD MODULE	15
4.2 BACKLIGHT UNIT.....	19
4.2.1 LIGHT BAR UNIT	19
4.2.2 CONVERTER UNIT	20
5. INTERFACE TIMING.....	22
5.1 INPUT SIGNAL TIMING SPECIFICATIONS	22
5.1.1 Timing spec for QFHD Mode Frame Rate =47~ 63Hz	22
5.2 TIMING DIAGRAM.....	25
5.2.1 V BY ONE SIGNAL TIMING DIAGRAM.....	25
5.3 BYTE LENGTH AND COLOR MAPPING OF V-BY-ONE HS.....	26
5.4 POWER ON/OFF SEQUENCE	27

6. OPTICAL CHARACTERISTICS 29

 6.1 TEST CONDITIONS 29

 6.2 OPTICAL SPECIFICATIONS 30

7. PRECAUTIONS 33

 7.1 ASSEMBLY AND HANDLING PRECAUTIONS 33

 7.2 SAFETY PRECAUTIONS 33

 7.3 Precautions for Strong Light Exposure 34

 7.4 SAFETY STANDARDS 35

8. DEFINITION OF LABELS 36

 8.1 MODULE LABEL 36

 8.2 CARTON LABEL 37

9. PACKAGING 38

 9.1 PACKAGING SPECIFICATIONS 38

 9.2 PACKAGING METHOD 38

 9.3 UN-PACKAGING METHOD 38

10. MECHANICAL CHARACTERISTIC 39

REVISION HISTORY

Version	Date	Page (New)	Section	Description
Ver. 0.0	19.Apr. 2023	All	All	The Tentative spec was first released

1. GENERAL DESCRIPTION

1.1 OVERVIEW

S850DJJ-T05 is a 84.5" TFT Liquid Crystal Display PID module with LED Backlight unit and 8Lanes V-by-One HS interface. This module supports 3840 x 2160 Quad Full HDTV format and can display true 1.07G colors (8-bit+FRC). The converter module for backlight is built-in.

1.2 FEATURES

- High brightness (3000 nits)
 - High contrast ratio (5000:1)
 - Fast response time (Gray to Gray typical : 9.5 ms)
 - High color saturation (NTSC 88%)
 - Quad Full HDTV (3840 x 2160 pixels) resolution, true HDTV format
 - V-by-One HS interface
 - Optimized response time for 50Hz/60Hz frame rate
 - Viewing Angle : 178(H)/178(V) (CR>10) VA Technology
 - Ultra wide viewing angle : Super MVA technology
 - RoHs compliance
 - T-con input frame rate * QFHD 47~63Hz
- Output frame rate: QFHD 47~63Hz

1.3 GENERAL SPECIFICATIONS

Item	Specification	Unit	Note
Active Area	1872(H)*1053(V) (85" diagonal)	mm	(1)
Bezel Opening Area	N/A	mm	
Driver Element	a-si TFT active matrix	-	-
Pixel Number	3840 x R.G.B. x 2160	pixel	-
Pixel Pitch (Sub Pixel)	0.1625 (H) x 0.4875 (V)	mm	-
Pixel Arrangement	RGB vertical stripe	-	-
Display Colors	1.07G colors (8-bit+FRC)	color	-
Display Operation Mode	Transmissive mode / Normally black	-	-
Surface Treatment	AG (haze~28%), Hardness=3H	-	(2)
Rotation Function	Unachievable		(3)
Display Orientation	Signal input with "INX"		(3)

Note (1) Please refer to the attached drawings in chapter 11 for more information about the front and back outlines.

Note (2) The spec of the surface treatment is temporarily for this phase. INX reserves the rights to change this feature.

Note (3)

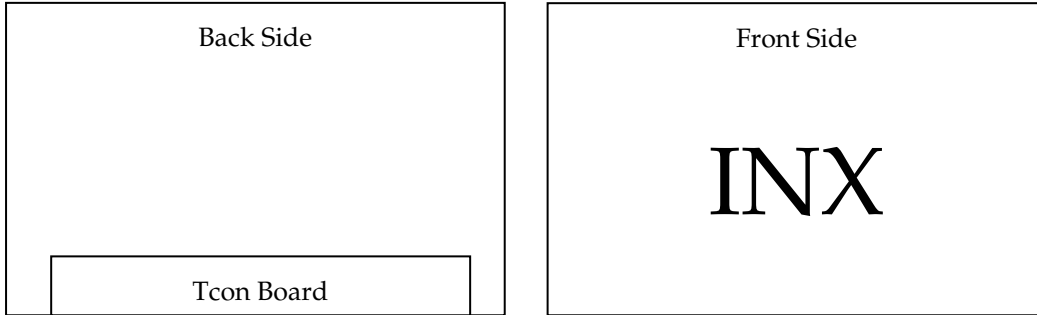

1.4 MECHANICAL SPECIFICATIONS

Item		Min.	Typ.	Max.	Unit	Note
Module Size	Horizontal (H)	1919.8	1921.8	1923.8	mm	(1),(2)
	Vertical (V)	1100.8	1102.8	1104.8	mm	(1),(2)
	Depth (D)	25.39	27.36	29.36	mm	To Rear
		-	TBD	-	mm	To CNV cover
Weight		TBD			g	

Note (1) Please refer to the attached drawings for more information of front and back outline dimensions.

Note (2) Module Depth does not include connectors.

2. ABSOLUTE MAXIMUM RATINGS

2.1 ABSOLUTE RATINGS OF ENVIRONMENT

Item	Symbol	Value		Unit	Note
		Min.	Max.		
Storage Temperature	T _{ST}	-20	+60	°C	(1)
Operating Ambient Temperature	T _{OP}	-20	+60	°C	(1), (2)
Panel Surface Temperature	P _{ST}	-	+65	°C	(2)

Note (1) Temperature and relative humidity range is shown in the figure below.

- (a) 90 %RH Max. (Ta ≤ 40 °C).
- (b) Wet-bulb temperature should be 39 °C Max.
- (c) No condensation.

Note (2) Surface temperature is measured at 60°C Dry condition.

Note (3) The rating of environment is base on LCD module. Leave LCD cell alone, this environment condition can't be guaranteed. Except LCD cell, the customer has to consider the ability of other parts of LCD module and LCD module process.

Note (4) Response time depends on the temperature. (In lower temperature, it becomes longer.)

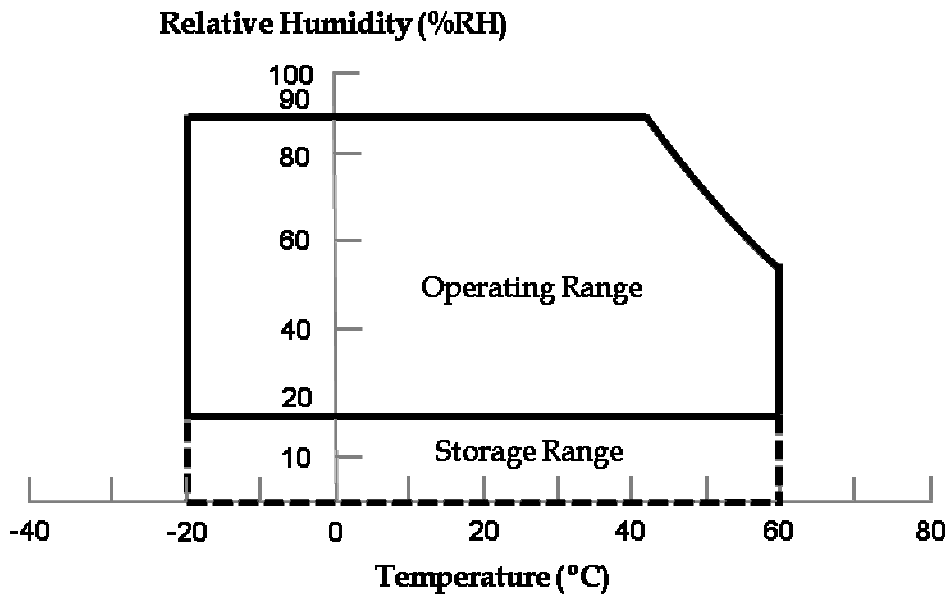

2.2 PACKAGE STORAGE

When storing modules as spares for a long time, the following precaution is necessary.

- (a) Do not leave the module in high temperature, and high humidity for a long time, It is highly recommended to store the module with temperature from 0 to 35 °C at normal humidity without condensation.
- (b) The module shall be stored in dark place. Do not store the TFT-LCD module in direct sunlight or fluorescent light.

2.3 ELECTRICAL ABSOLUTE RATINGS

2.3.1 TFT LCD MODULE

Item	Symbol	Value		Unit	Note
		Min.	Max.		
Power Supply Voltage	V _{CC}	-0.3	13.5	V	(1)
Logic Input Voltage	V _{IN}	-0.3	3.6	V	

Note (1) Permanent damage to the device may occur if maximum values are exceeded. Function operation should be restricted to the conditions described under Normal Operating Conditions

2.3.2 BACKLIGHT CONVERTER UNIT

Item	Symbol	Value		Unit	Note
		Min.	Max.		
Light Bar Voltage	V _W	—	65	VRMS	
Converter Input Voltage	V _{BL}	0	30	V	(1)
Control Signal Level	—	-0.3	6	V	(1), (3)

Note (1) Permanent damage to the device may occur if maximum values are exceeded. Functional operation should be restricted to the conditions described under normal operating conditions.

Note (2) No moisture condensation or freezing.

3. ELECTRICAL CHARACTERISTICS

3.1 TFT LCD MODULE

(Ta = 25 ± 2 °C)

Parameter	Symbol	Value			Unit	Note	
		Min.	Typ.	Max.			
Power Supply Voltage	V _{CC}	10.8	12	13.2	V	(1)	
Rush Current	I _{RUSH}	—	—	(5.33)	A	(2)	
Power Consumption	White Pattern	P _T	—	(37.95)	(41.745)	W	(3)
	Black Pattern	P _T	—	(15.787)	(17.367)	W	
	Horizontal Stripe	P _T	—	(37.536)	(41.29)	W	
Power Supply Current	White Pattern	—	—	(3.648)	(3.952)	A	(3)
	Black Pattern	—	—	(1.512)	(1.638)	A	
	Horizontal Stripe	—	—	(3.6)	(3.9)	A	
VbyOne HS	Differential Input High Threshold Voltage	VLVTH			+50	mV	
	Differential Input Low Threshold Voltage	VLVTL	-50			mV	
	Differential Input Resistor	RRIN	80	100	120	ohm	
CMOS interface	Input High Threshold Voltage	VIH	2.7		3.6	V	
	Input Low Threshold Voltage	VIL	0		0.7	V	

Note (1) The module should be always operated within the above ranges. The ripple voltage should be controlled under 10% of V_{CC} (Typ.)

Note (2) Measurement condition :

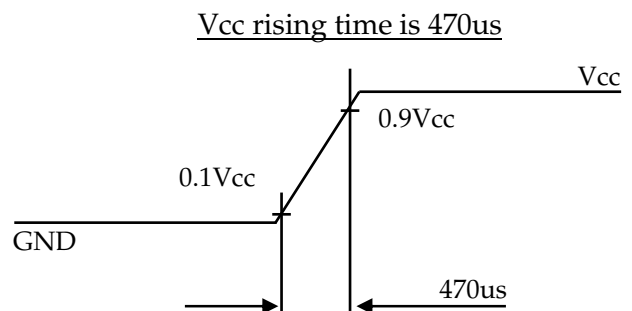
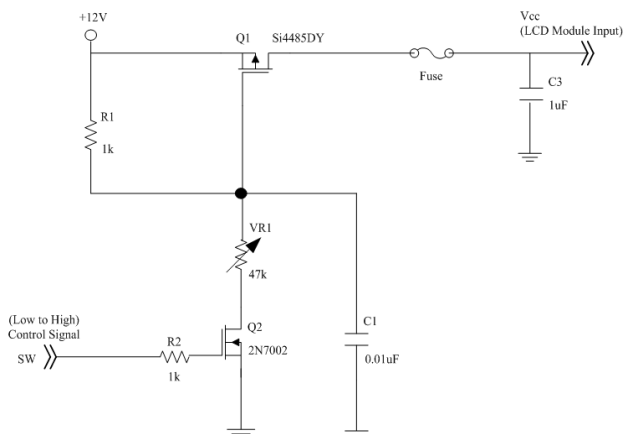

Note (3) The specified power supply current is under the conditions at $V_{cc} = 12\text{ V}$, $T_a = 25 \pm 2\text{ }^\circ\text{C}$, $f_v = 60\text{ Hz}$, whereas a power dissipation check pattern below is displayed.

a. White Pattern



Active Area

b. Black Pattern

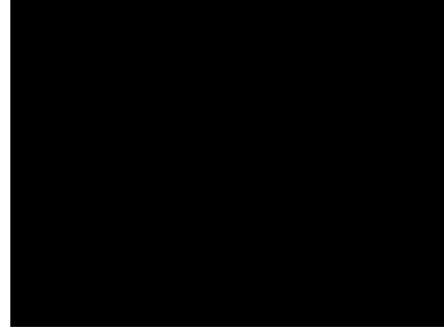

Active Area

c. Horizontal Stripe

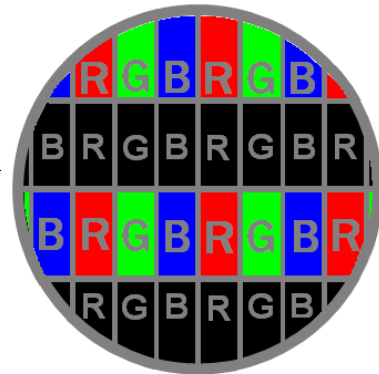
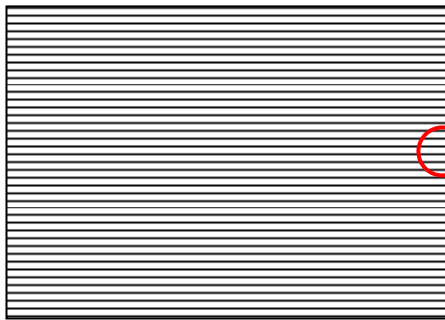

3.2 BACKLIGHT CONVERTER UNIT

3.2.1 CONVERTER CHARACTERISTICS

Parameter	Symbol	Value			Unit	Note
		Min.	Typ.	Max.		
Power Consumption	P _{BL}	-	1334	1535	W	(1), (2)
Converter Input Voltage	V _{BL}	22.8	24.0	25.2	VDC	
Converter Input Current	I _{BL}	-	55.5	64	A	Non Dimming
Input Inrush Current	I _R	-	-	TBD	A _{peak}	V _{BL} =22.8V ₇ (3), (6)
Dimming Frequency	FB	150	160	170	Hz	(5)
Dimming Duty Ratio	DDR	5	-	100	%	(4), (5)
Life Time	-	30,000	50,000	-	Hrs	(7)

Note (1) The power supply capacity should be higher than the total converter power consumption P_{BL}. Since the pulse width modulation (PWM) mode was applied for backlight dimming, the driving current changed as PWM duty on and off. The transient response of power supply should be considered for the changing loading when converter dimming.

Note (2) The measurement condition of Max. value is based on 85" backlight unit under input voltage 24V, at 2D Mode and lighting 1 hour later.

Note (3) For input inrush current measure, the V_{BL} rising time from 10% to 90% is about 20ms.

Note (4) EPWM signal have to input available duty range. Between 97% and 100% duty (DDR) have to be avoided. (97% < DDR < 100%) But 100% duty (DDR) is possible. 5% duty (DDR) is only valid for electrical operation.

Note (5) FB and DDR are available only at 2D Mode.

Note (6) Below diagram is only for power supply design reference.

Test Condition : $V_{BL} = 22.8V$ at 2D Mode

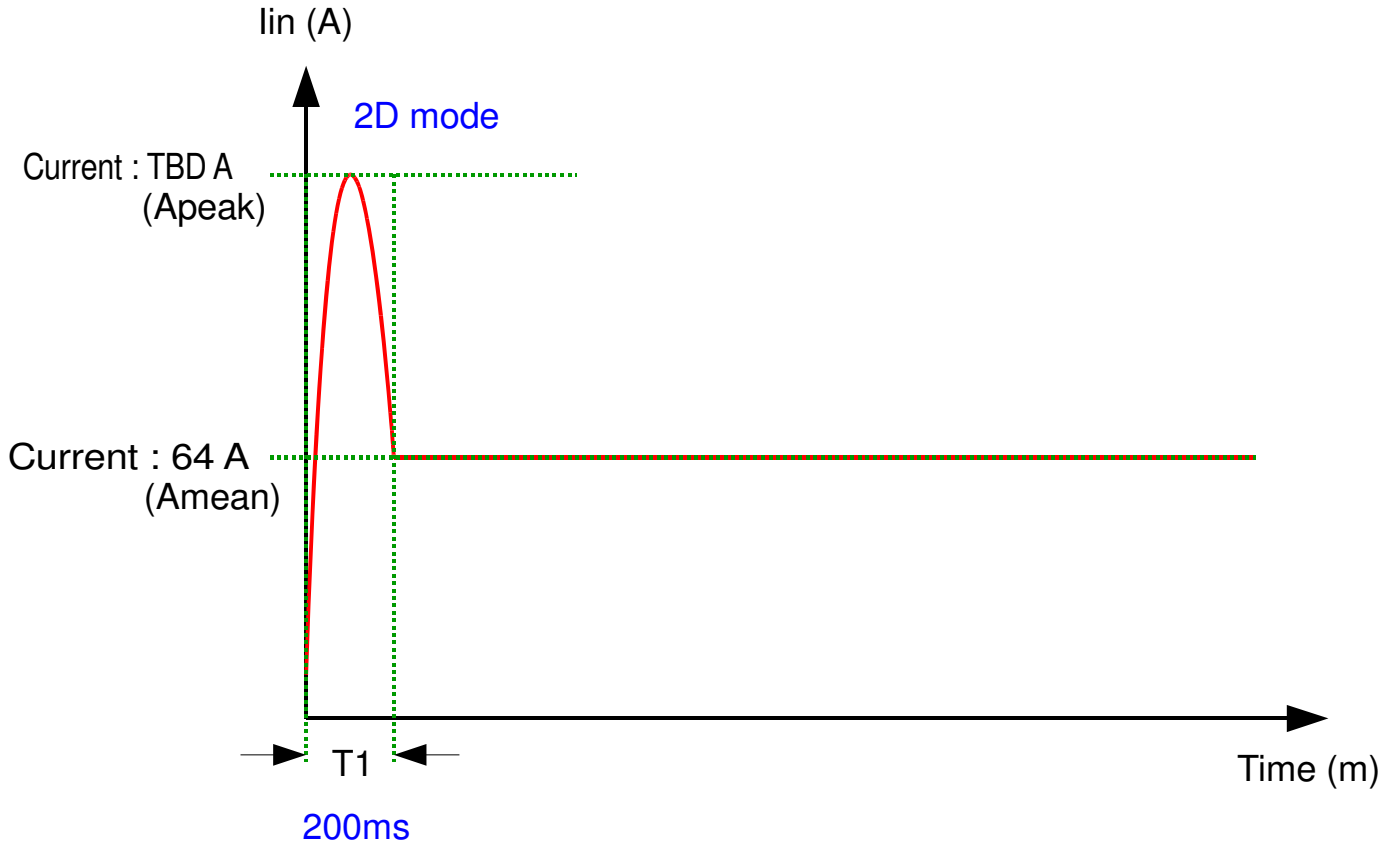

Note (7) The lifetime is defined as the time which luminance of the LED decays to 50% compared to the initial value,
Operating condition: Continuous operating at $T_a = 25 \pm 2^\circ C$

3.2.2 CONVERTER INTERFACE CHARACTERISTICS

Parameter	Symbol	Test Condition	Value			Unit	Note		
			Min.	Typ.	Max.				
On/Off Control Voltage	ON	VBLON	—	2.0	—	5.0	V		
	OFF		—	0	—	0.8	V		
External PWM Control Voltage	HI	VEPWM	—	2.0	—	5.25	V	Duty on	(5), (6)
	LO		—	0	—	0.8	V	Duty off	
Error Signal	ERR	—	—	—	—	—	Abnormal: Open		
VBL Rising Time	Tr1	—	20	—	—	ms	10%-90%V _{BL}		
Control Signal Rising Time	Tr	—	—	—	100	ms			
Control Signal Falling Time	Tf	—	—	—	100	ms			
PWM Signal Rising Time	TPWMR	—	—	—	50	us	(6)		
PWM Signal Falling Time	TPWMF	—	—	—	50	us			
Input Impedance	Rin	—	1	—	—	MΩ	EPWM, BLON		
PWM Delay Time	TPWM	—	100	—	—	ms	(6)		
BLON Delay Time	T _{on}	—	300	—	—	ms			
	T _{on1}	—	300	—	—	ms			
BLON Off Time	Toff	—	300	—	—	ms			

Note (1) The Dimming signal should be valid before backlight turns on by BLON signal. It is inhibited to change the external PWM signal during backlight turn on period.

Note (2) The power sequence and control signal timing are shown in the Fig.1. For a certain reason, the converter has a possibility to be damaged with wrong power sequence and control signal timing.

Note (3) While system is turned ON or OFF, the power sequences must follow as below descriptions:

Turn ON sequence: VBL → PWM signal → BLON

Turn OFF sequence: BLOFF → PWM signal → VBL

Note (4) When converter protective function is triggered, ERR will output open collector status. Please refers to Fig.2.

Note (5) The EPWM interface that inserts a pull up resistor to 5V in Max Duty (100%), please refers to Fig.3.

Note (6) EPWM is available only at 2D Mode.

Note (7) EPWM signal have to input available frequency range.

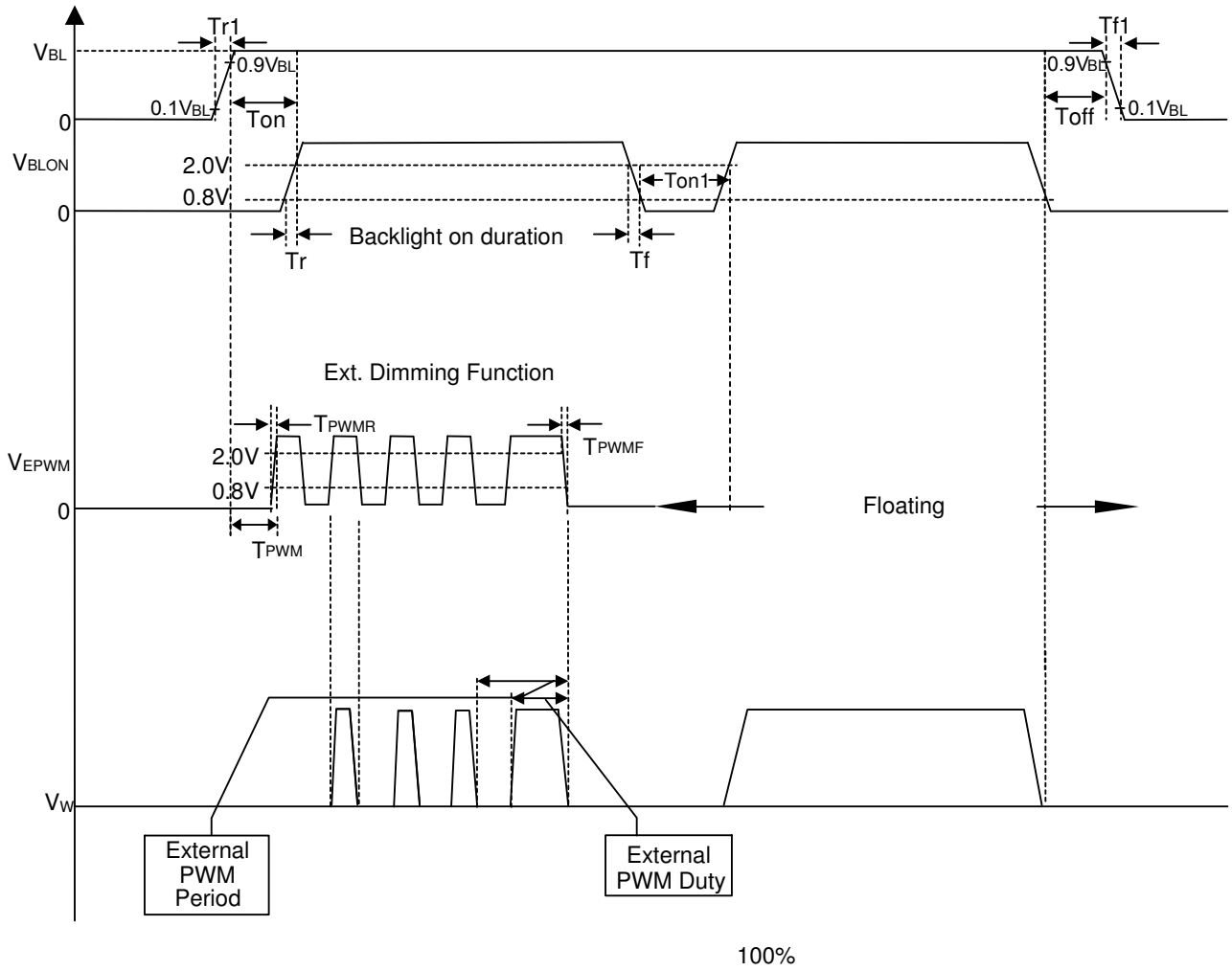

Fig. 1

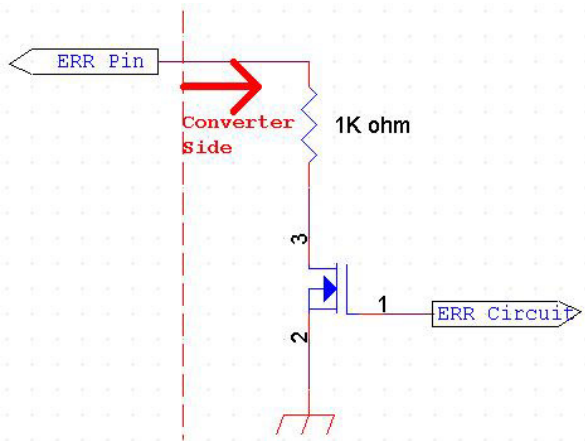

Fig. 2

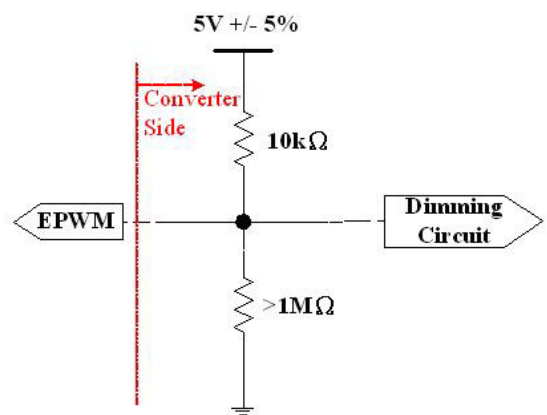

Fig. 3

4. INPUT TERMINAL PIN ASSIGNMENT

4.1 TFT LCD MODULE

CNC08 Connector Pin Assignment: [5-05162216-1(XDYT), FF01-42T-5131(FCN)]

Matting Connector

Pin	Name	Description	Note
1	N.C.	No Connection	(4)
2	N.C.	No Connection	
3	N.C.	No Connection	
4	N.C.	No Connection	
5	N.C.	No Connection	
6	N.C.	No Connection	
7	N.C.	No Connection	
8	N.C.	No Connection	
9	N.C.	No Connection	(4)
10	GND	Ground	
11	GND	Ground	
12	GND	Ground	
13	GND	Ground	
14	GND	Ground	
15	N.C.	No Connection	(4)
16	N.C.	No Connection	(4)
17	N.C.	No Connection	(4)
18	N.C.	No Connection	(4)
19	N.C.	No Connection	(4)
20	N.C.	No Connection	(4)
21	N.C.	No Connection	(4)
22	LD_EN	Local Dimming Mode Enable.	
23	N.C.	No Connection	(4)
24	N.C.	No Connection	(4)
25	HTPDN	No Connection or ground	(6)
26	LOCKN	Lock detect output, Open drain.	
27	GND	Ground	
28	RX0N	1 ST Pixel Negative VbyOne differential data input in area A. Lan 0	(1)

29	RX0P	1 ST Pixel Positive VbyOne differential data input in area A. Lan 0	(1)
30	GND	Ground	
31	RX1N	2 ND Pixel Negative VbyOne differential data input in area A. Lan 1	(1)
32	RX1P	2 ND Pixel Positive VbyOne differential data input in area A. Lan 1	
33	GND	Ground	
34	RX2N	3 RD Pixel Negative VbyOne differential data input in area A. Lan 2	(1)
35	RX2P	3 RD Pixel Positive VbyOne differential data input in area A. Lan 2	
36	GND	Ground	
37	RX3N	4 TH Pixel Negative VbyOne differential data input in area A. Lan 3	(1)
38	RX3P	4 TH Pixel Positive VbyOne differential data input in area A. Lan 3	
39	GND	Ground	
40	RX4N	5 TH Pixel Negative VbyOne differential data input in area A. Lan 4	(1)
41	RX4P	5 TH Pixel Positive VbyOne differential data input in area A. Lan 4	
42	GND	Ground	
43	RX5N	6 TH Pixel Negative VbyOne differential data input in area A. Lan 5	(1)
44	RX5P	6 TH Pixel Positive VbyOne differential data input in area A. Lan 5	
45	GND	Ground	
46	RX6N	7 TH Pixel Negative VbyOne differential data input in area A. Lan 6	(1)
47	RX6P	7 TH Pixel Positive VbyOne differential data input in area A. Lan 6	
48	GND	Ground	
49	RX7N	8 TH Pixel Negative VbyOne differential data input in area A. Lan 7	(1)
50	RX7P	8 TH Pixel Positive VbyOne differential data input in area A. Lan 7	
51	GND	Ground	

CNC07 Connector Pin Assignment: [CI0105M1HR0-LA-NH(瀚荃), JH2-D4-053N(全康-FCN)]

Matting connector: [PHR5(JST)]

1	GND	Ground	
2	GND	Ground	
3	Vin	Power input (+12V)	(5)
4	Vin	Power input (+12V)	
5	Vin	Power input (+12V)	

Note (1) V-by-One HS Data Mapping

Area	Lane	Data Stream
A	Lane 0	1, 9, 17,, 3825, 3833
	Lane 1	2, 10, 18,, 3826, 3834
	Lane 2	3, 11, 19,, 3827, 3835
	Lane 3	4, 12, 20,, 3828, 3836
	Lane 4	5, 13, 21,, 3829, 3837
	Lane 5	6, 14, 22,, 3830, 3838
	Lane 6	7, 15, 23,, 3831, 3839
	Lane 7	8, 16, 24,, 3832, 3840

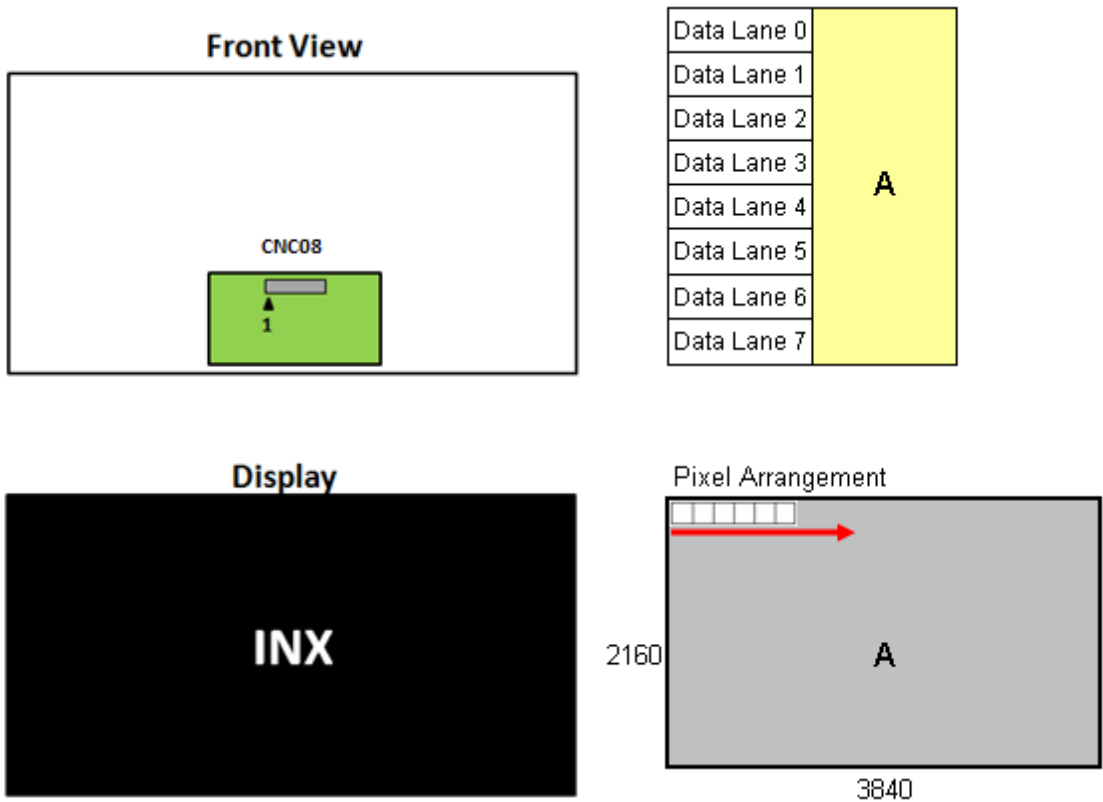

Note (2) V-by-One HS connector pin order defined as follows

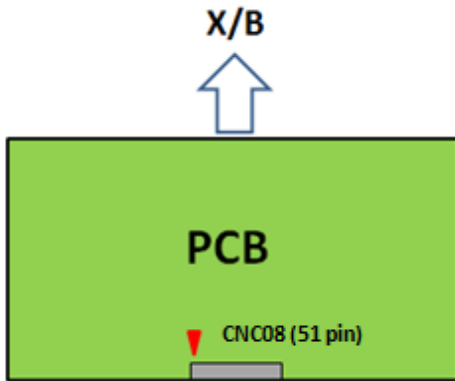

Note (3) V-by-One connector mating dimension range request is 0.27mm~0.33mm as below

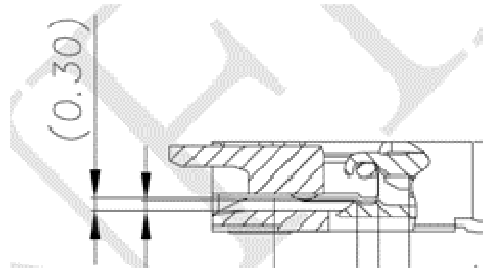

Note (4) Reserved for internal use. Please leave it open.

Note (5) Power input (+12V), Please check the current rating of FFC cable to meet the power consumption requirement.

Note (6) This pin connect to ground internal, but it could be open

Note (7) V-by-One connector Recommend Mating FFC drawing as below.

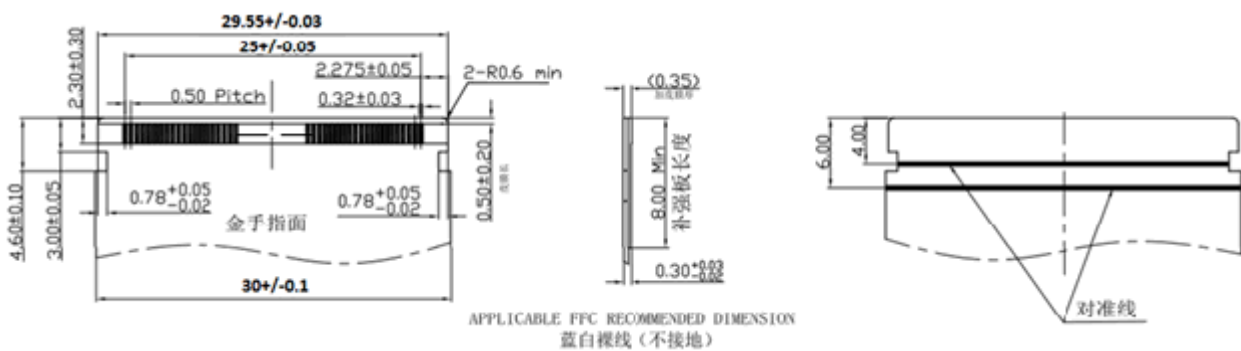

4.2 BACKLIGHT UNIT

4.2.1 LIGHT BAR UNIT

The pin configuration for the housing and lead wire is shown in the table below.

CNL01 Connector Pin Assignment: [TBD]

Pin No	Symbol	Feature
TBD	TBD	TBD
TBD	TBD	TBD
TBD	TBD	TBD
TBD	TBD	TBD
TBD	TBD	TBD
TBD	TBD	TBD

Note (1) Light Bar Input connector pin order defined as follows

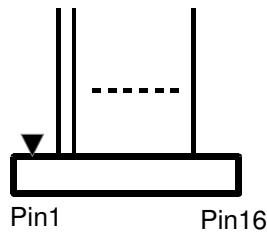

Input Connector

4.2.2 CONVERTER UNIT

CNV1 Connector Pin Assignment: [CI0114M1HR0-LA (CvilLux) , JH2-D4-143N (FCN)]

Matting connector : [JST PHR-14]

Pin No.	Symbol	Feature
1	VBL	+24V
2		
3		
4		
5		
6	GND	GND
7		
8		
9		
10		
11	ERR	Normal (GND) ; Abnormal (Open collector)
12	BLON	BL ON/OFF
13	NC	NC
14	E_PWM	External PWM Control

Note (1) Input connector pin order defined as follows

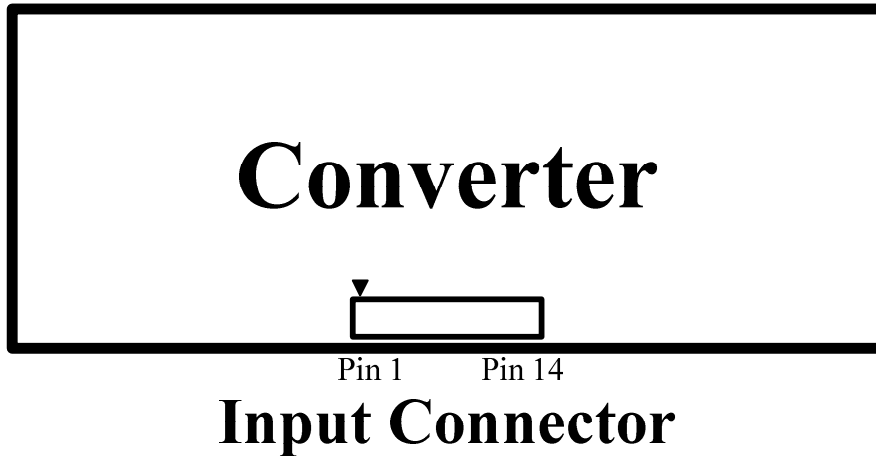

CNV02 Connector Pin Assignment: [CI0112M1HR0-LA (CvilLux) or JH2-D4-123N (FCN)]

Matting connector : [JST PHR-12]

Pin No.	Symbol	Feature
1	VBL	+24V
2		
3		
4		
5		
6	GND	GND
7		
8		
9		
10		
11	NC	NC
12	NC	NC

Note (1) Input connector pin order defined as follows

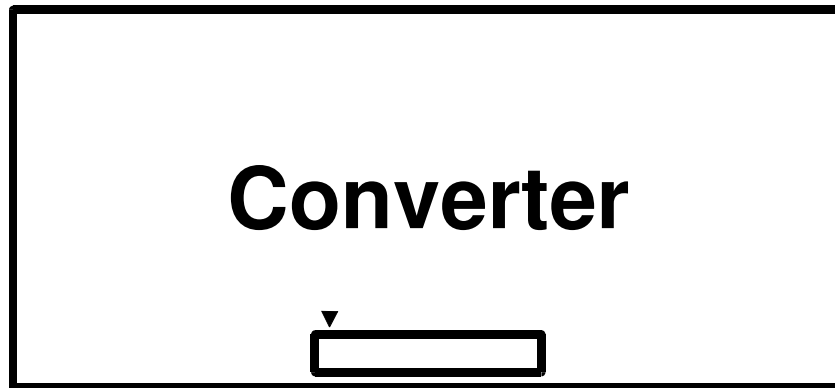

Input Connector

5. INTERFACE TIMING

5.1 INPUT SIGNAL TIMING SPECIFICATIONS

The input signal timing specifications are shown as the following table and timing diagram. (Ta = 25 ± 2 °C)

Signal	Item	Symbol	Min.	Typ.	Max.	Unit	Note
VbyOne Receiver	Intra-Pair skew		-0.3		0.3	UI	(2)
	Inter-Pair skew		- 5		5	UI	(3)
	Spread spectrum modulation range	F _{clk_{in}_mod}	1/Tc-0.5%	—	1/Tc+0.5%	MHz	(4)
	Spread spectrum modulation frequency	F _{SSM}	—	—	30	KHz	

5.1.1 Timing spec for QFHD Mode Frame Rate =47~ 63Hz

Signal	Item	Symbol	Min.	Typ.	Max.	Unit	Note
Frequency	Data Clock	1/Tc	70	74.25	80	MHz	(1)
Frame rate	QFHD Mode	Fr	47	60	63	Hz	(5),(6)
Horizontal Frequency		Fh	122.8	135	140	KHz	
Vertical Active Display Term (8 Lan,3840X2160 Active Area)	Total	Tv	2200	2250	2790	Th	Tv=Tvd+Tvb
	Display	Tvd	2160			Th	
	Blank	Tvb	40	90	630	Th	
Horizontal Active Display Term (8 Lan,3840X2160 Active Area)	Total	Th	530	550	570	Tc	Th=Thd+Thb
	Display	Thd	480			Tc	
	Blank	Thb	50	70	90	Tc	

Note (1) Please make sure the range of pixel clock has follow the below equation :

$$F_{clk}(max) \geq Fr \times Tv \times Th$$

$$Fr \times Tv \times Th \geq F_{clk}(min)$$

INPUT SIGNAL TIMING DIAGRAM

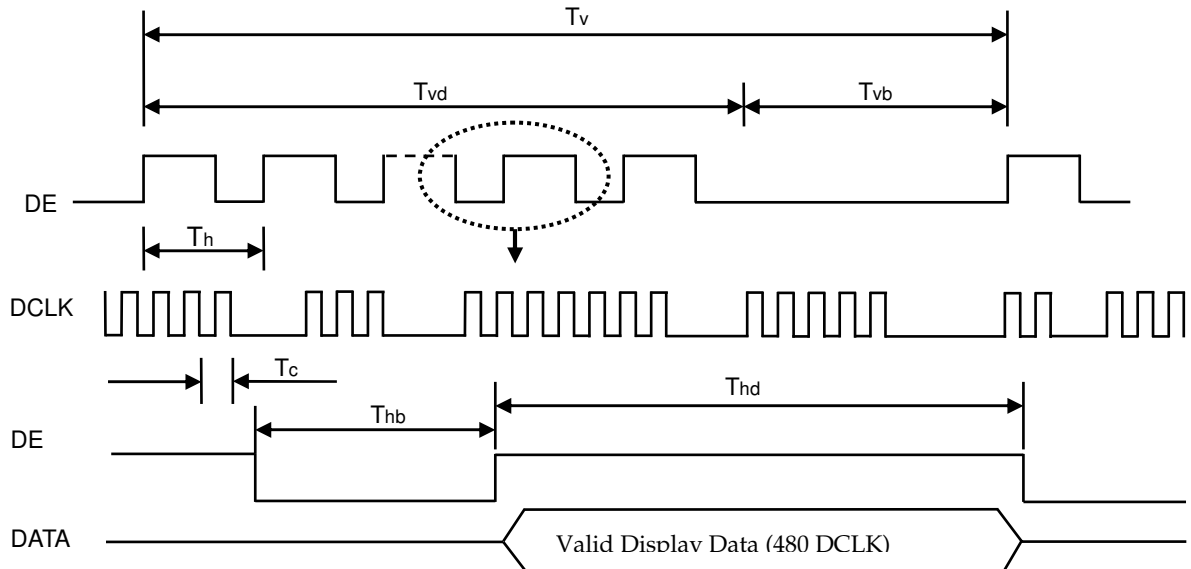

Note (2) VbyOne HS Intra-pair skew

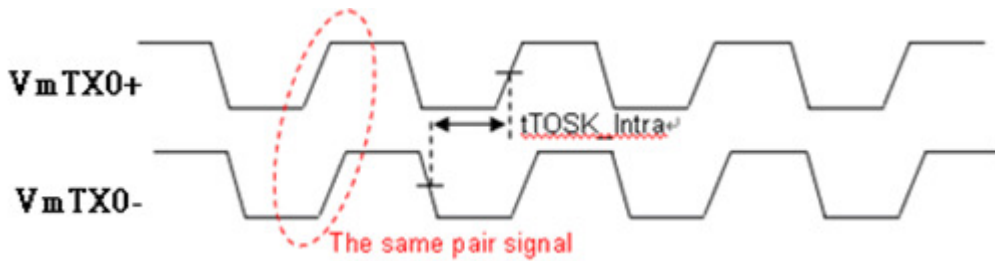

Note (3) VbyOne HS Inter-pair skew

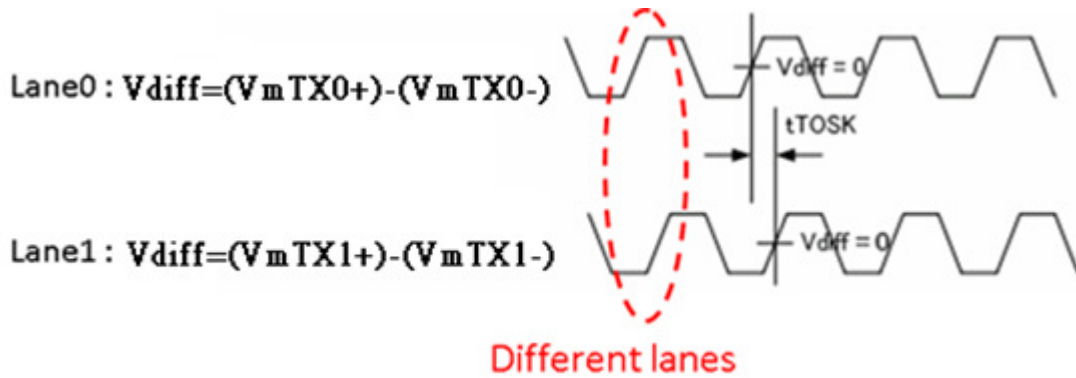

Note (4) The SSCG (Spread spectrum clock generator) is defined as below figures.

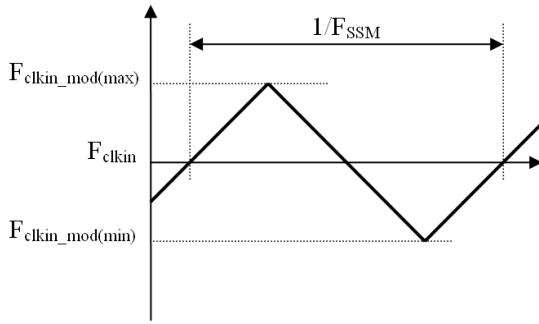

Note (5) For converter reference signals, The frame-to-frame jitter of the input frame rate is defined as the above figures. $FR_n = FR_{n-1} \pm 1.8\%$.

Note (6) For converter reference signals, The setup of the frame rate jitter $> 1.8\%$ may result in the cosmetic LED backlight symptom.

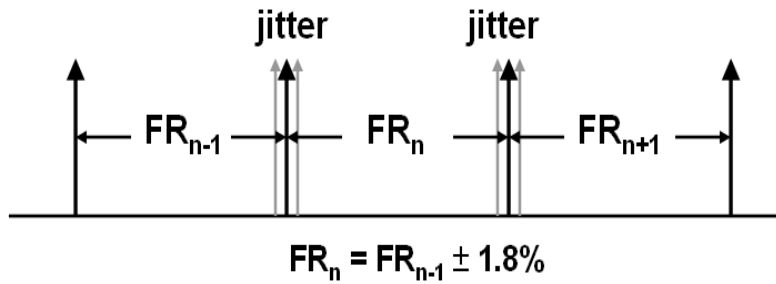

5.2 TIMING DIAGRAM

5.2.1 V BY ONE SIGNAL TIMING DIAGRAM

The eye diagram is measured by the oscilloscope and receiver CDR characteristic must be emulated.

PLL bandwidth: 40MHz

Damping facto: 1.4

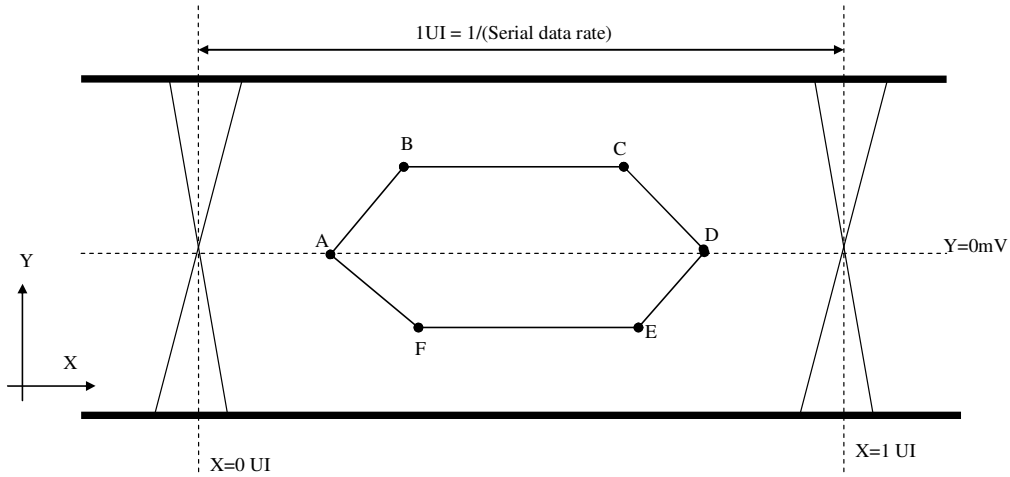

Table 1 Eye Mask Specification

	X [UI]	Y [mV]	Note
A	0.25	0	(1)
B	0.3	50	(1)
C	0.7	50	(1)
D	0.75	0	(1)
E	0.7	-50	(1)
F	0.3	-50	(1)

Note (1) Input levels of V-by-One HS signals are comes from “V-by-One HS Stander Ver.1.4”

5.3 BYTE LENGTH AND COLOR MAPPING OF V-BY-ONE HS

Packer input & Unpacker output	30bpp RGB (10bit)	
Byte 0	D[0]	R[2]
	D[1]	R[3]
	D[2]	R[4]
	D[3]	R[5]
	D[4]	R[6]
	D[5]	R[7]
	D[6]	R[8]
	D[7]	R[9]
Byte 1	D[8]	G[2]
	D[9]	G[3]
	D[10]	G[4]
	D[11]	G[5]
	D[12]	G[6]
	D[13]	G[7]
	D[14]	G[8]
	D[15]	G[9]
Byte 2	D[16]	B[2]
	D[17]	B[3]
	D[18]	B[4]
	D[19]	B[5]
	D[20]	B[6]
	D[21]	B[7]
	D[22]	B[8]
	D[23]	B[9]
Byte 3	D[24]	X
	D[25]	X
	D[26]	B[0]
	D[27]	B[1]
	D[28]	G[0]
	D[29]	G[1]
	D[30]	R[0]
	D[31]	R[1]

5.4 POWER ON/OFF SEQUENCE

To prevent a latch-up or DC operation of LCD module, the power on/off sequence should be as the diagram below.

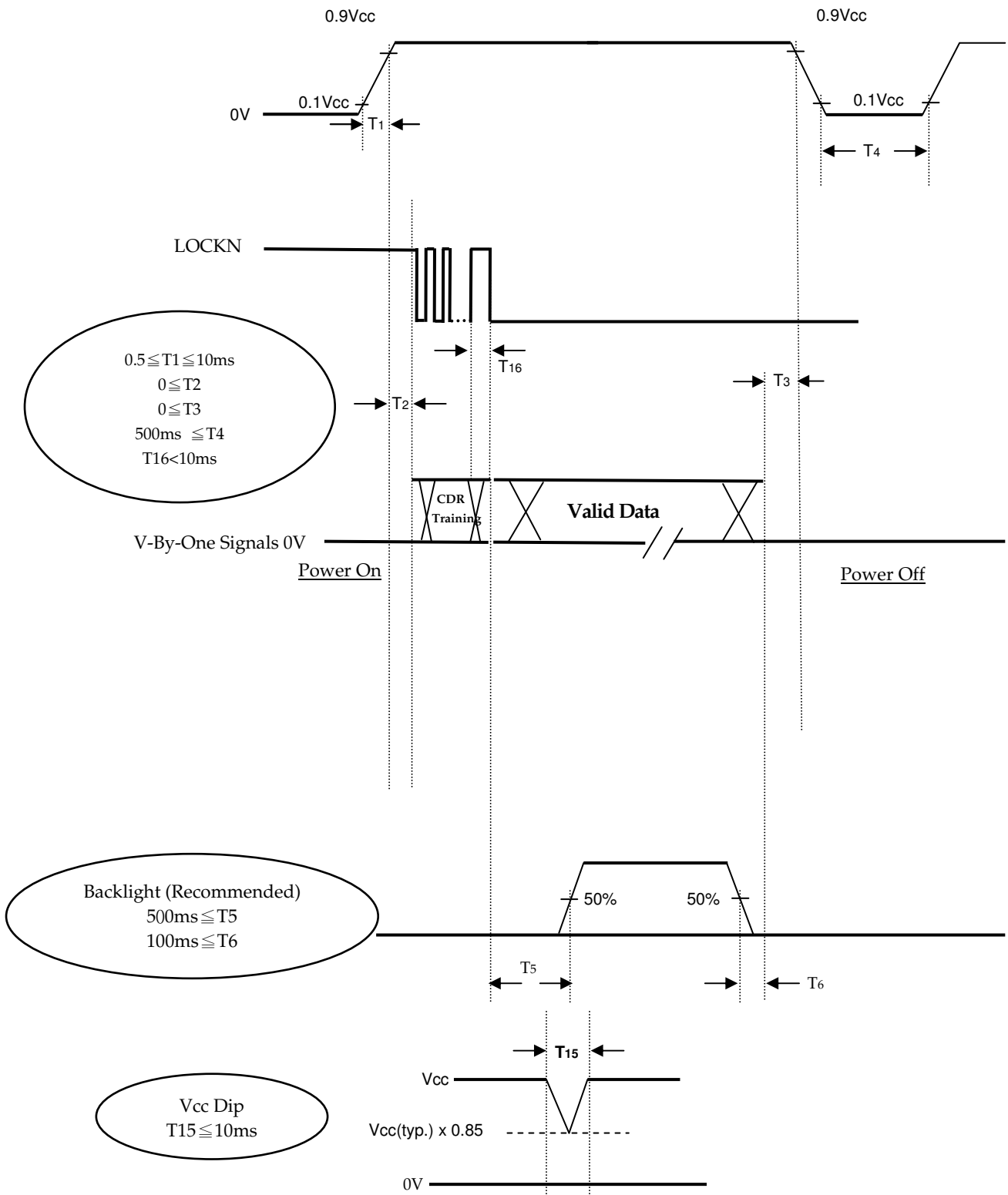

- Note (1) The supply voltage of the external system for the module input should follow the definition of Vcc.
- Note (2) Apply the LED voltage within the LCD operation range. When the backlight turns on before the LCD operation or the LCD turns off before the backlight turns off, the display may momentarily become abnormal screen.
- Note (3) In case of Vcc is in off level, please keep the level of input signals on the low or high impedance besides HTPDN and LOCKN. If T2<0, that maybe cause electrical overstress failure.
- Note (4) T4 should be measured after the module has been fully discharged between power off and on period.
- Note (5) Interface signal shall not be kept at high impedance when the power is on.
- Note (6) Vcc must decay smoothly when power-off.
- Note (7) HTPDN(internal ground) : For customer reference signal. It can be ignored if customer not use.
- Note (8) T16 , V-by-One signals shall be stabilized and follows timing specification which defined by section 5.1&5.2

6. OPTICAL CHARACTERISTICS

6.1 TEST CONDITIONS

Item	Symbol	Value	Unit
Ambient Temperature	Ta	25±2	°C
Ambient Humidity	Ha	50±10	%RH
Supply Voltage	V _{CC}	12±1.2	V
Input Signal	According to typical value in "3. ELECTRICAL CHARACTERISTICS"		
Vertical Frame Rate	Fr	60	Hz

The LCD module should be stabilized at given temperature for 1 hour to avoid abrupt temperature change during measuring in a windless room.

Local Dimming Function should be Disable before testing to get the steady optical characteristics (According to 5.1 CNF1 Connector Pin Assignment, Pin no. "22")

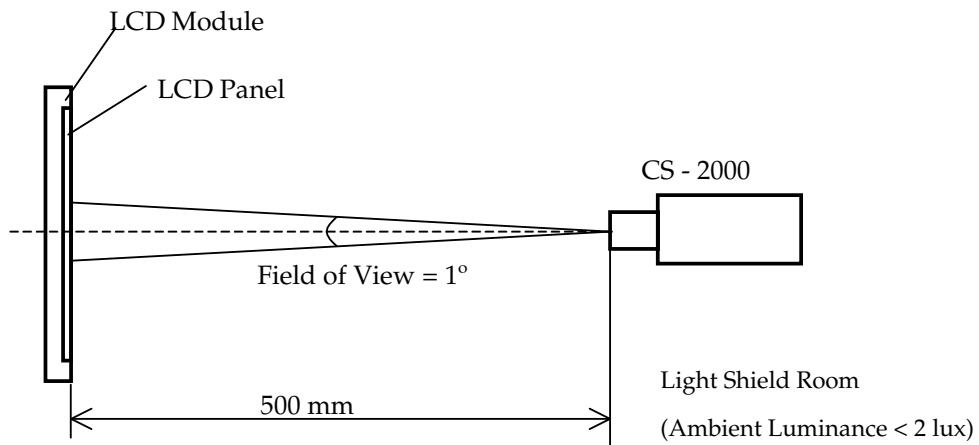

6.2 OPTICAL SPECIFICATIONS

The relative measurement methods of optical characteristics are shown in 6.2. The following items should be measured under the test conditions described in 6.1 and stable environment shown in 6.1.

Item		Symbol		Condition	Min.	Typ.	Max.	Unit	Note				
Contrast Ratio		CR		$\theta_x=0^\circ, \theta_y=0^\circ$ Viewing angle at normal direction	3500	5000		-	Note (2)				
Response Time		Gray to gray				9.5	19	ms	Note (3)				
Center Luminance of White		L _C	2D		2400	3000		cd/m ²	Note (4)				
White Variation		δW					1.3	-	Note (6)				
Cross Talk		CT	2D				4	%	Note (5)				
Color Chromaticity	Red	R _x			Viewing angle at normal direction	Typ.- 0.03	0.672	Typ.+ 0.03	-				
		R _y		0.309			-						
	Green	G _x		0.259			-						
		G _y		0.656			-						
	Blue	B _x		0.154			-						
		B _y		0.049			-						
	White	W _x		0.280			-						
		W _y		0.290			-						
	Correlated color temperature						10000					K	
	Color Gamut		C.G.				-		88		-	%	NTSC
Viewing Angle	Horizontal	θ_{x+}		CR \geq 10	80	89	-	Deg.	(1)				
		θ_{x-}			80	89	-						
	Vertical	θ_{y+}			80	89	-						
		θ_{y-}			80	89	-						

Note (1) Definition of Viewing Angle (θ_x, θ_y) :

Viewing angles are measured by Autronic Conoscope Cono-80 (or Eldim EZ-Contrast 160R).

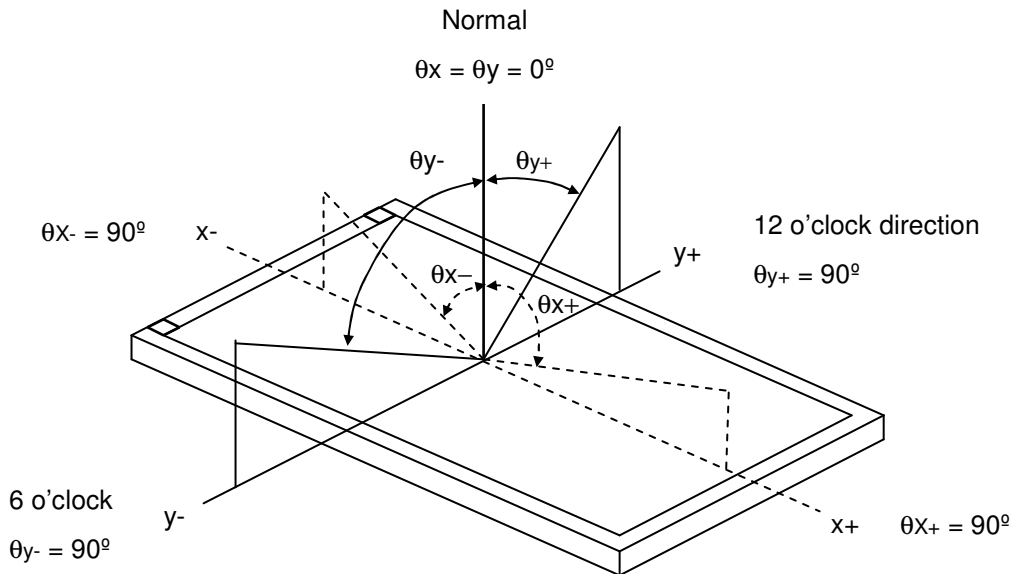

Note (2) Definition of Contrast Ratio (CR) :

The contrast ratio can be calculated by the following expression.

$$\text{Contrast Ratio (CR)} = \frac{\text{Surface Luminance of L1023}}{\text{Surface Luminance of L0}}$$

L1023: Luminance of gray level 1023

L 0: Luminance of gray level 0

CR = CR (X), where CR (X) is corresponding to the Contrast Ratio of the point X at the figure in Note (6).

Note (3) Definition of Gray-to-Gray Switching Time :

Optical Response

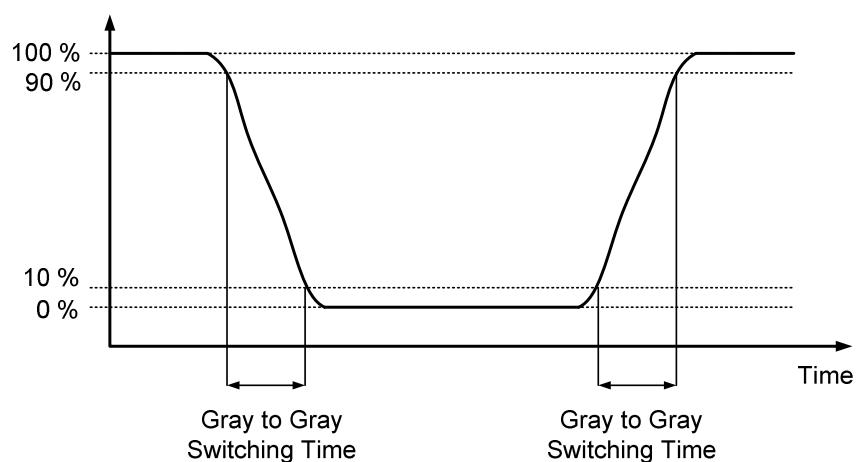

The driving signal means the signal of gray level 0, 124, 252, 380, 508, 636, 764, 892 and 1023.

Gray to gray average time means the average switching time of gray level 0, 124, 252, 380, 508, 636, 764, 892 and 1023 to each other.

Note (4) Definition of Luminance of White (L_C) :

Measure the luminance of gray level 1023 at center point.

$L_C = L(5)$, where $L(x)$ is corresponding to the luminance of the point X at the figure in Note (6).

Note (5) Definition of Cross Talk (CT) :

$$CT = |Y_B - Y_A| / Y_A \times 100 (\%)$$

Where :

Y_A = Luminance of measured location without gray level 1023 pattern (cd/m²)

Y_B = Luminance of measured location with gray level 1023 pattern (cd/m²)

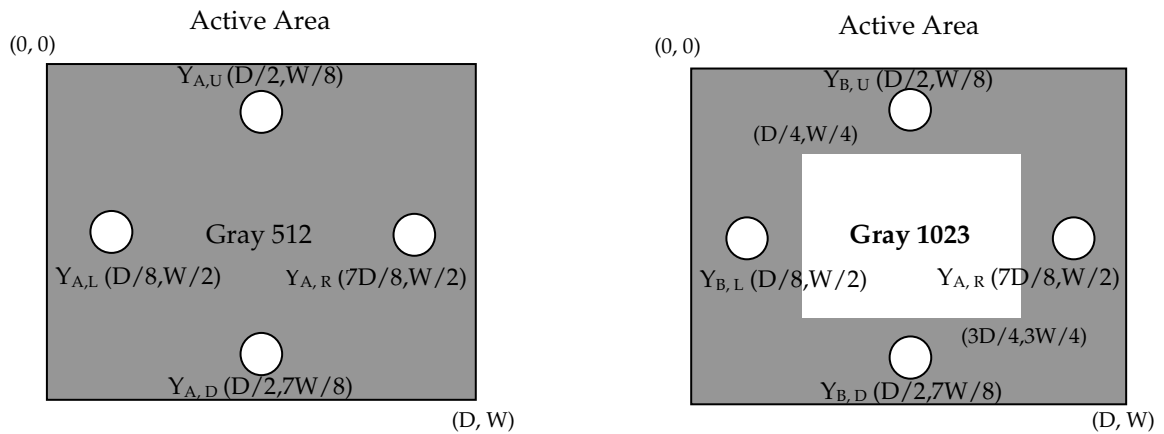

Note (6) Definition of White Variation (δW):

Measure the luminance of gray level 1023 at 5 points

$$\delta W = \frac{\text{Maximum}[L(1), L(2), L(3), L(4), L(5)]}{\text{Minimum}[L(1), L(2), L(3), L(4), L(5)]}$$

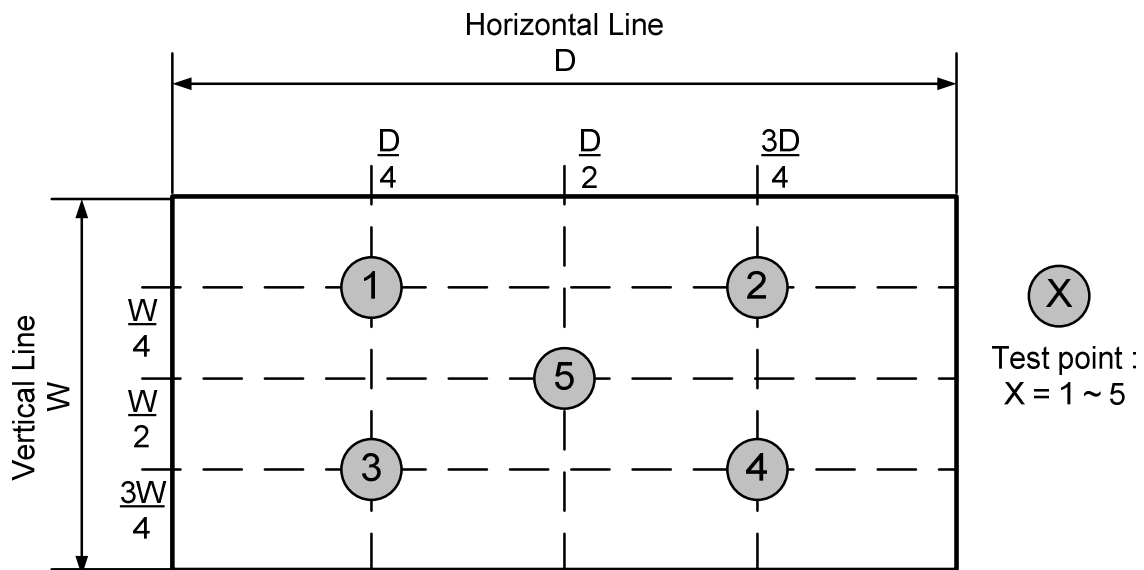

Note (7) Strong light exposure causes degradation of polarizer and color filter.

7. PRECAUTIONS

7.1 ASSEMBLY AND HANDLING PRECAUTIONS

- [1] Do not apply rough force such as bending or twisting to the module during assembly.
- [2] Do not apply pressure or impulse to the module to prevent the damage of LCD panel and Backlight.
- [3] Bezel of Set can not press or touch the panel surface. It will make light leakage or scrape.
- [4] It should be attached to the system firmly using all mounting holes.
- [5] It is recommended to assemble or to install a module into the user's system in clean working areas. The dust and oil may cause electrical short or worsen the polarizer, do not press or scratch the surface harder than a HB pencil lead.
- [6] Use finger-stalls with soft gloves in order to keep display clean during the incoming inspection and assembly process.
- [7] Protection film for polarizer on the module should be slowly peeled off just before use so that the electrostatic charge can be minimized.
- [8] Do not disassemble the module.
- [9] Always follow the correct power-on sequence when the LCD module is turned on. This can prevent the damage and latch-up of the CMOS LSI chips.
- [10] Do not plug in or pull out the I/F connector while the module is in operation, pins of I/F connector should not be touched directly with bare hands. Do not adjust the variable resistor located on the module.
- [11] Moisture can easily penetrate into LCD module and may cause the damage during operation.
- [12] When storing modules as spares for a long time, the following precaution is necessary.
 - [12.1] Do not leave the module in high temperature, and high humidity for a long time. It is highly recommended to store the module with temperature from 0 to 35°C at normal humidity (under 70%) without condensation.
 - [12.2] The module shall be stored in dark place. Do not store the TFT-LCD module in direct sunlight or fluorescent light.
- [13] When ambient temperature is lower than 10°C, the display quality might be reduced. For example, the response time will become slow, and the starting voltage of LED will be higher than that of room temperature.
- [14] Use a soft dry cloth without chemicals and Ethyl Alcohol for cleaning, because the surface of polarizer is very soft and easily scratched. Do not use Ketone type materials (ex. Acetone), Toluene, Ethyl acid or Methyl chloride, these chemical solvent might permanently damage the polarizer due to chemical action.

7.2 SAFETY PRECAUTIONS

To optimize PID module's lifetime and functions, operating conditions should be followed as below

- [1] Normal operating condition
 - [1.1] Operating temperature: -20~60°C
 - [1.2] Operating humidity: 20~90%
 - [1.3] Well-ventilated place is suggested to set up PID module and system.
 - [1.4] Display pattern : regular switched patterns or moving pictures.

- [2] Operating usage to protect against image sticking due to long-term static display.
 - [2.1] Suitable operating time : under 24 hours a day.
 - (* The moving picture can be allowed for 24 hours a day)
 - [2.2] Liquid Crystal refresh time is required. Cycling display between 5 minutes' information (static) display and 10 seconds' moving image.
 - [2.3] Periodical display contents should be changed from static image to moving picture.
 - [2.3.1] Different background and image colors changed respectively, and changed colors periodically.
 - [2.3.2] Background and image with large different luminance displayed at the same time should be avoided.
 - [2.3.3] Periodical power-off the system for a while or screen saver is needed after long-term static display.
 - [2.3.4] Moving picture or black pattern is strongly recommended for screen saver.
- [3] The startup voltage of a Backlight may cause an electrical shock while assembling with the converter. Do not disassemble the module or insert anything into the Backlight unit.
- [4] Do not connect or disconnect the module in the "Power On" condition.
- [5] Do not exceed the absolute maximum rating value. (supply voltage variation, input voltage variation, variation in part contents and environmental temperature...) Otherwise the module may be damaged.
- [6] If the liquid crystal material leaks from the panel, it should be kept away from the eyes or mouth. In case of contact with hands, skin or clothes, it has to be washed away thoroughly with soap.
- [7] Module should be turned counterclockwise (regular front view perspective) when used in portrait mode.
- [8] Ultra-violet ray filter is necessary for outdoor operation.
- [9] Only when PID module is operated under right operating conditions, lifetime in this spec can be guaranteed. After the module's end of life, it is not harmful in case of normal operation and storage.
- [10] Product reliability and functions are only guaranteed when the product is used under right operation usages. If product will be used in extreme conditions, especially combining severe conditions such as high temperature/humidity, display stationary patterns, or long operation time etc..., it is strongly recommended to contact INX for field application engineering advice. Otherwise, the panel may be damaged and its reliability and function may not be guaranteed. Extreme conditions are commonly found at airports, transit stations, banks, stock market and full outdoor display.

7.3 Precautions for Strong Light Exposure

- [1] Strong light exposure causes degradation of polarizer and color filter. Since the product design is not protected by CG(cover glass), the deterioration of the polarizer due to sun exposure or water drenching is not guarantee.
- [2] To keep display function well as a digital signage application, especially the component of TFT is very sensitive to sunlight, it is necessary to set up blocking device protecting panel from radiation of ambient environment.

7.4 SAFETY STANDARDS

The LCD module should be certified with safety regulations as follows:

Regulatory	Item	Standard
Information Technology equipment	UL	UL60950-1:2006 or Ed.2:2007
	cUL	CAN/CSA C22.2 No.60950-1-03 or 60950-1-07
	CB	IEC60950-1:2005 / EN60950-1:2006+ A11:2009
Audio/Video Apparatus	UL	UL60065 Ed.7:2007
	cUL	CAN/CSA C22.2 No.60065-03:2006 + A1:2006
	CB	IEC60065:2001+ A1:2005 / EN60065:2002 + A1:2006+ A11:2008

If the module displays the same pattern for a long period of time, the phenomenon of image sticking may be occurred.

8. DEFINITION OF LABELS

8.1 MODULE LABEL

The barcode nameplate is pasted on each module as illustration, and its definitions are as following explanation.

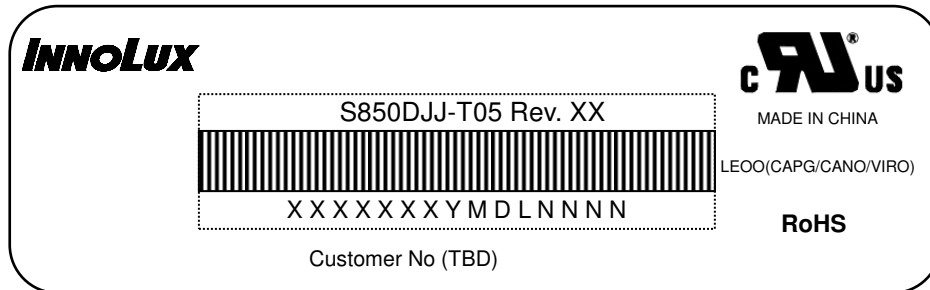

Model Name : S850DJJ-T05

Revision : Rev. XX, for example: A0, A1... B1, B2... or C1, C2...etc.

Serial ID : X X X X X X Y M D L N N N N

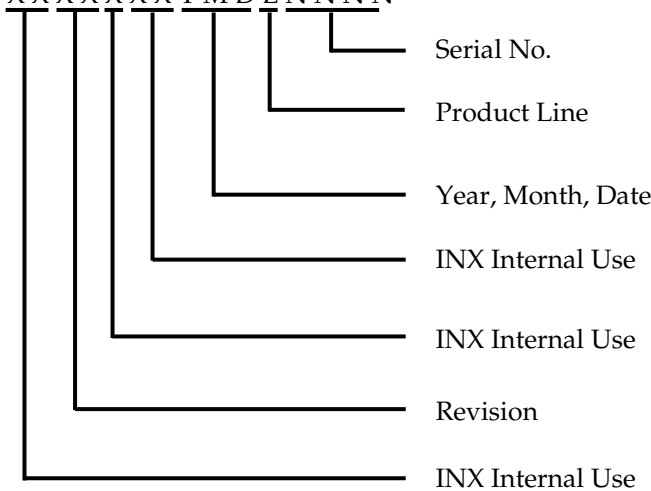

Serial ID includes the information as below :

Manufactured Date :

Year : 2001=1, 2002=2, 2003=3, 2004=4...2010=0, 2011=1, 2012=2...

Month: 1~9, A~C, for Jan. ~ Dec.

Day: 1~9, A~Y, for 1st to 31st, exclude I ,O, and U.

Revision Code : Cover all the change

Serial No. : Manufacturing sequence of product

Product Line : 1→Line1, 2→Line 2, ...etc.

8.2 CARTON LABEL

The barcode nameplate is pasted on each box as illustration, and its definitions are as following explanation.



Model Name: S850DJJ-T05

Carton ID: X X X X X X Y M D X X X X

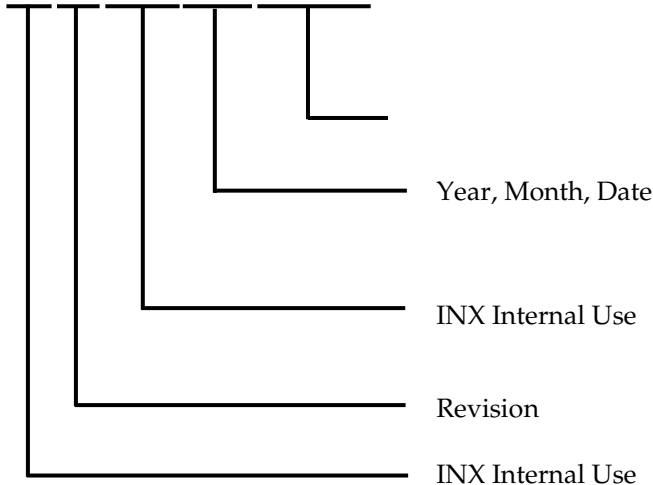

Serial ID includes the information as below :

Manufactured Date:

Year: 2010=0, 2011=1, 2012=2...etc.

Month: 1~9, A~C, for Jan. ~ Dec.

Day: 1~9, A~Y, for 1st to 31st, exclude I ,O, and U.

Revision Code: Cover all the change

9. PACKAGING

9.1 PACKAGING SPECIFICATIONS

T.B.D

9.2 PACKAGING METHOD

T.B.D

9.3 UN-PACKAGING METHOD

T.B.D

10. MECHANICAL CHARACTERISTIC

TBD

Our company network supports you worldwide with offices in Germany, Austria, Switzerland, the UK and the USA. For more information please contact:

Headquarters

Germany



FORTEC Elektronik AG

Augsburger Str. 2b
82110 Germering

Phone: +49 89 894450-0
E-Mail: info@forteca.de
Internet: www.forteca.de

Fortec Group Members

Austria



Distec GmbH Office Vienna

Nuschinggasse 12
1230 Wien

Phone: +43 1 8673492-0
E-Mail: info@distec.de
Internet: www.distec.de

Germany



Distec GmbH

Augsburger Str. 2b
82110 Germering

Phone: +49 89 894363-0
E-Mail: info@distec.de
Internet: www.distec.de

Switzerland



ALTRAC AG

Bahnhofstraße 3
5436 Würenlos

Phone: +41 44 7446111
E-Mail: info@altrac.ch
Internet: www.altrac.ch

United Kingdom



Display Technology Ltd.

Osprey House, 1 Osprey Court
Hichingbrooke Business Park
Huntingdon, Cambridgeshire, PE29 6FN

Phone: +44 1480 411600
E-Mail: info@displaytechnology.co.uk
Internet: www.displaytechnology.co.uk

USA



Apollo Display Technologies, Corp.

87 Raynor Avenue,
Unit 1 Ronkonkoma,
NY 11779

Phone: +1 631 5804360
E-Mail: info@apolloDisplays.com
Internet: www.apolloDisplays.com